

TRANSFER SWITCH DETAILS									
ATS NAME	QTY	AMPS / POLES (VOLTS)	BYPASS	TRANSITION TYPE	CATALOG NUMBER	ACCESSORIES	OUTLINE DRAWING	WIRING DIAGRAM	BOM NUMBER
	3	1600 / 4 (480V)	N/A	OPEN	G03ATSB31600NGXM	11BE,44G	609798-021	1001662	1387784
	3	2000 / 4 (480V)	N/A	OPEN	G03ATSB32000NGXM	11BE,44G	1001395-002	1001662	1154425
	3	2600 / 4 (480V)	N/A	OPEN	G03ATSB32600NGXM	11BE,44G	1001395-003	1001662	1090132
	2	3000 / 4 (480V)	N/A	OPEN	G03ATSB33000NGXM	11BE,44G	1001395-003	1001662	1154426
	1	4000 / 4 (480V)	N/A	OPEN	G07ATSB34000N5XM	44G	844459-002	844627	1529266

Transfer Switch Withstand and Closing Ratings																					
300, 4000 & 7000 Series																					
ATS NAME	FRAME SIZE	SWITCH RATING AMPS		CURRENT LIMITING FUSES				SPECIFIC BREAKER			TIME BASED			Short Time Ratings ³ (sec)							
		Transfer Switches	Bypass Switches	480V Max.	600V Max.	MAX SIZE, A	CLASS	240V Max.	480V Max.	600V Max.	Time(Sec)	240V Max.	480V Max.	600V Max.	480V Max.				600V Max.		
															.13	.2	.3	.5	.1	.13	.3
-	G ⁸	1600 - 2000	1600 - 2000	200kA	200kA	3000	L	200kA	200kA	100kA	0.05	100kA	100kA	100kA	42kA	36kA	42kA	-			
-	G	2600-3000	2600 - 3000	200kA	200kA	4000	L	125kA ⁶	125kA ⁶	100kA	0.05	100kA	100kA	100kA	42kA	36kA	42kA	-			
-	G	4000	4000	200kA	200kA	5000	L	100kA	100kA	100kA	0.05	100kA	100kA	100kA	85kA	65kA	65kA	-			

NOTES:

- 1) All WCR values indicated are tested in accordance with the requirements of UL 1008, 7th Edition.
- 2) Application requirements may permit higher WCR for certain switch sizes.
- 3) Short Time ratings are provided for applications involving circuit breakers that utilize trip delay settings for system selective coordination
- 6) Rating shown is for Bypass switches only, Transfer Switch rating is 100kA
- 8) These frames are only available on the 7000 Series product

#2	ATS	AMPS: 2000	QTY: 3
Product	: Series 300	Catalog Number	: G03ATSB32000NGXM
Service Voltage / Hz	: 480V/60Hz	Optional Accessories	: 11BE,44G
Bypass Isolation	: Not Applicable	Product Description	: 300 Series, Automatic Open Transition Transfer Switch
No. of Switched Poles: 4	: 4	Neutral Configuration	: Switched [B]
Withstand Rating:	: See WCR Table Below	No. of Cables & Lug Size	: See applicable outline drawing
Frame = G, Switch Rating = 2000, Series = 300			
Enclosure	: 3R(M)-UL Type 3R secure double door enclosure (See Disclaimer 3)	Service	: Three Phase, 4-wire
Extended Warranty	: Not Included	Markings	:

#	ACCESSORY DESCRIPTIONS	
	Accessory Code	Description
1	11BE	Adds the following features to the Group G controller: (1) Serial RS-485 Modbus Communications (2) Multi-Schedule Engine Exerciser (3) a 300 Entry Event Log and (4) a common alarm output function. When applied on 3-phase systems it also enables: (1) 3-Phase Emergency Source VLL sensing (2) Phase Rotation Monitoring (3) Emergency Source VLL Unbalance Monitoring.
2	44G	Strip heater w/ thermostat, wired to load terminals: 208-600 volts

8 7 6 5 4 3 2 1

OUTLINE FOR ASCO® 300 SERIES 2000 AMPERE "G" FRAME (G3ATS,G3NTS,G3ADTS,G3NDTS) FRONT CONNECTED TRANSFER SWITCHES TYPE 3R/3RX SECURE ENCLOSURE

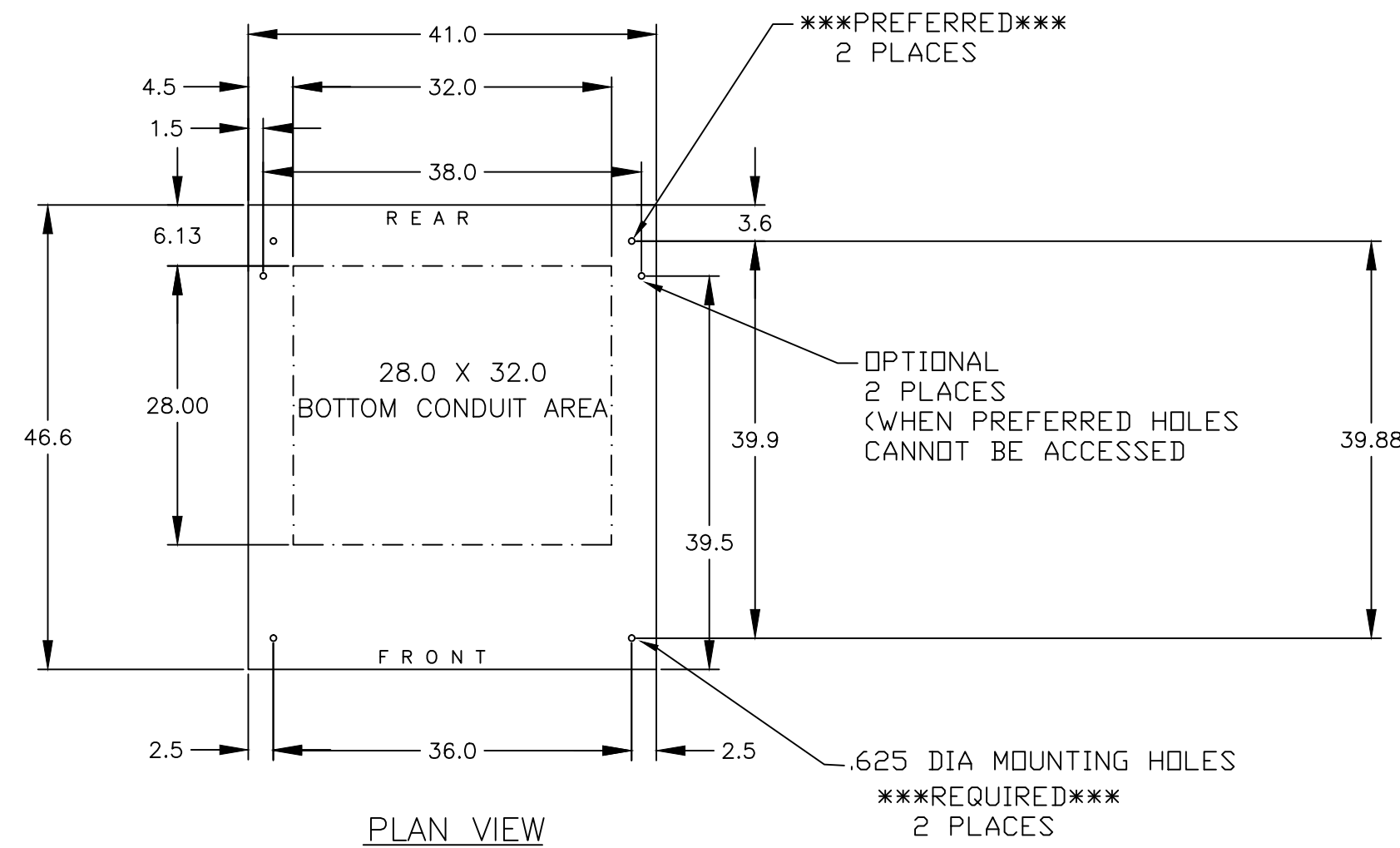
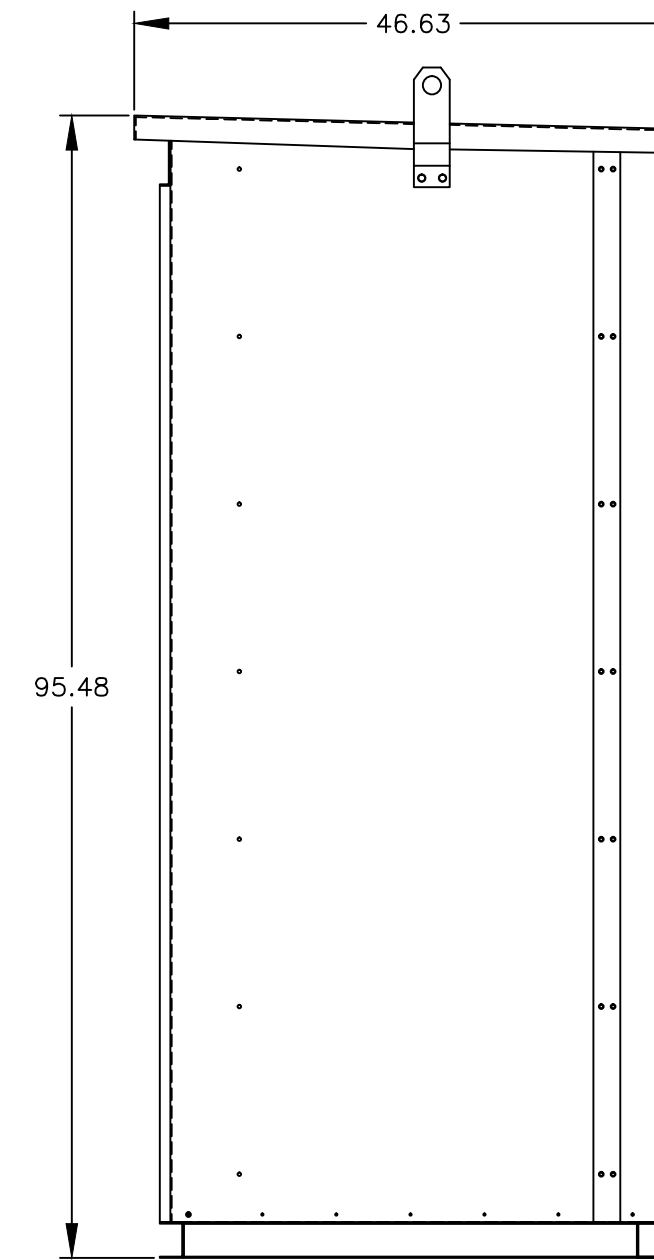
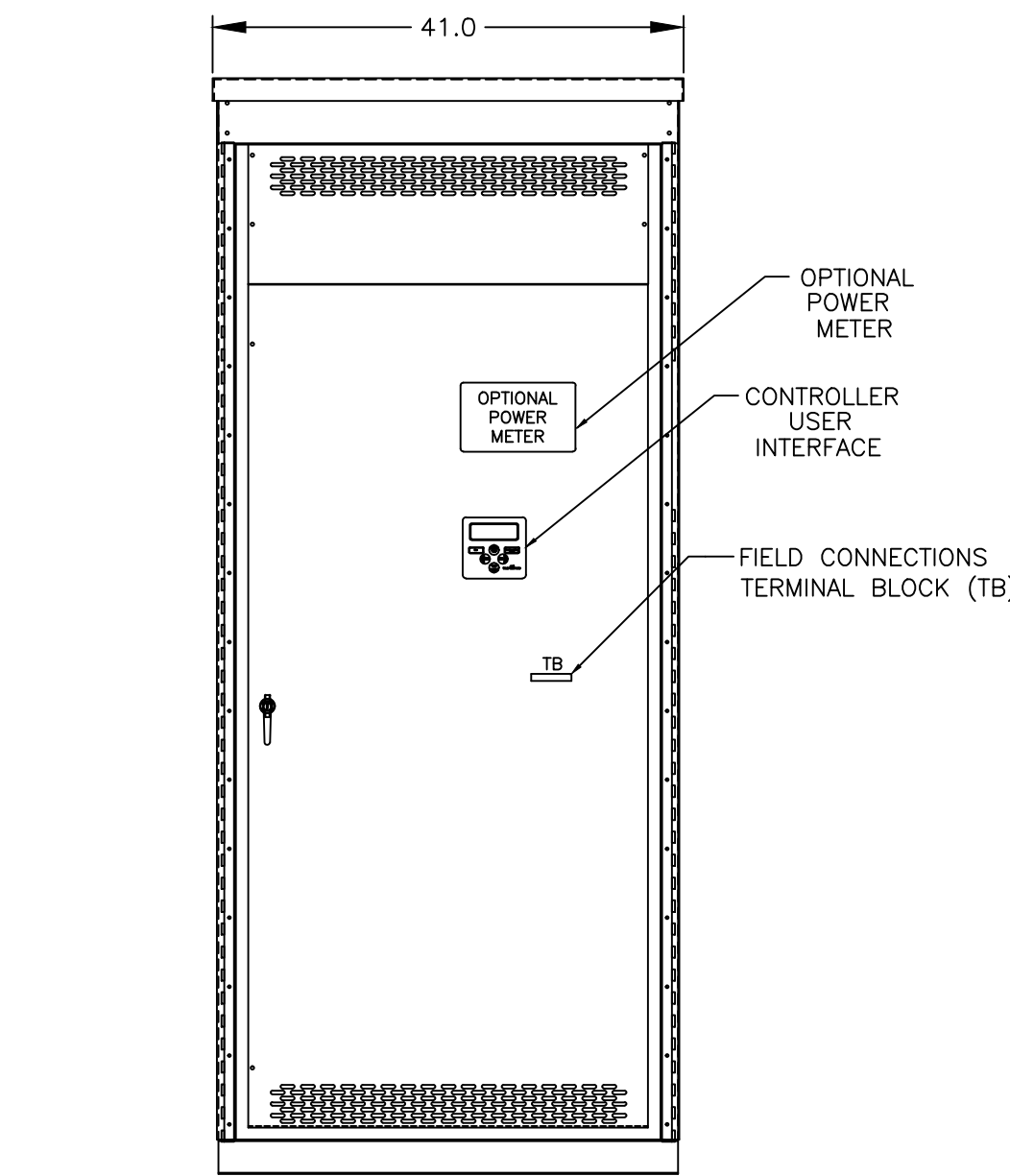
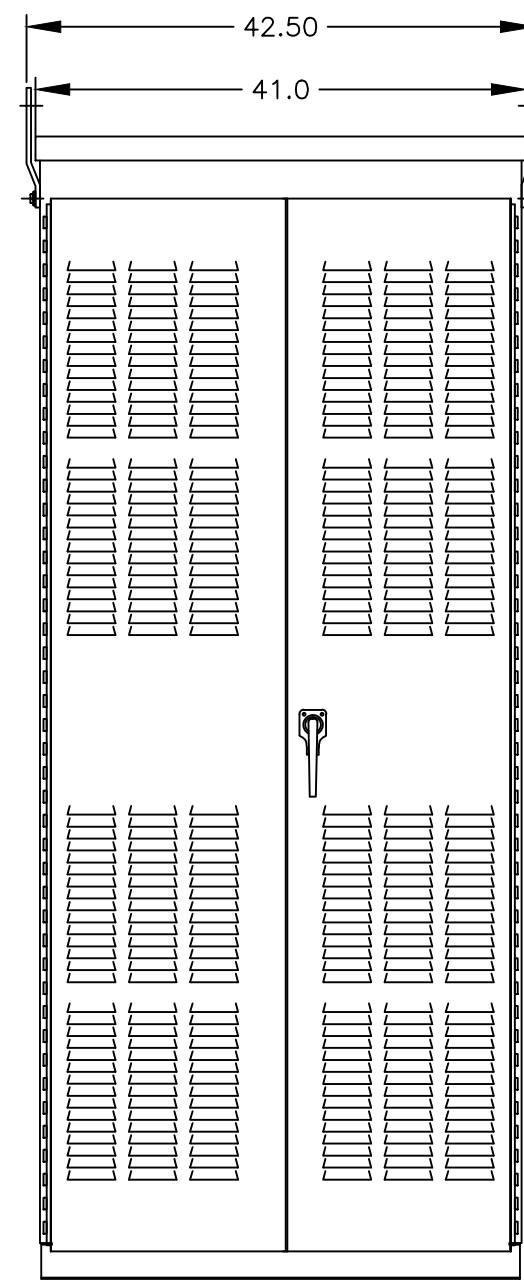
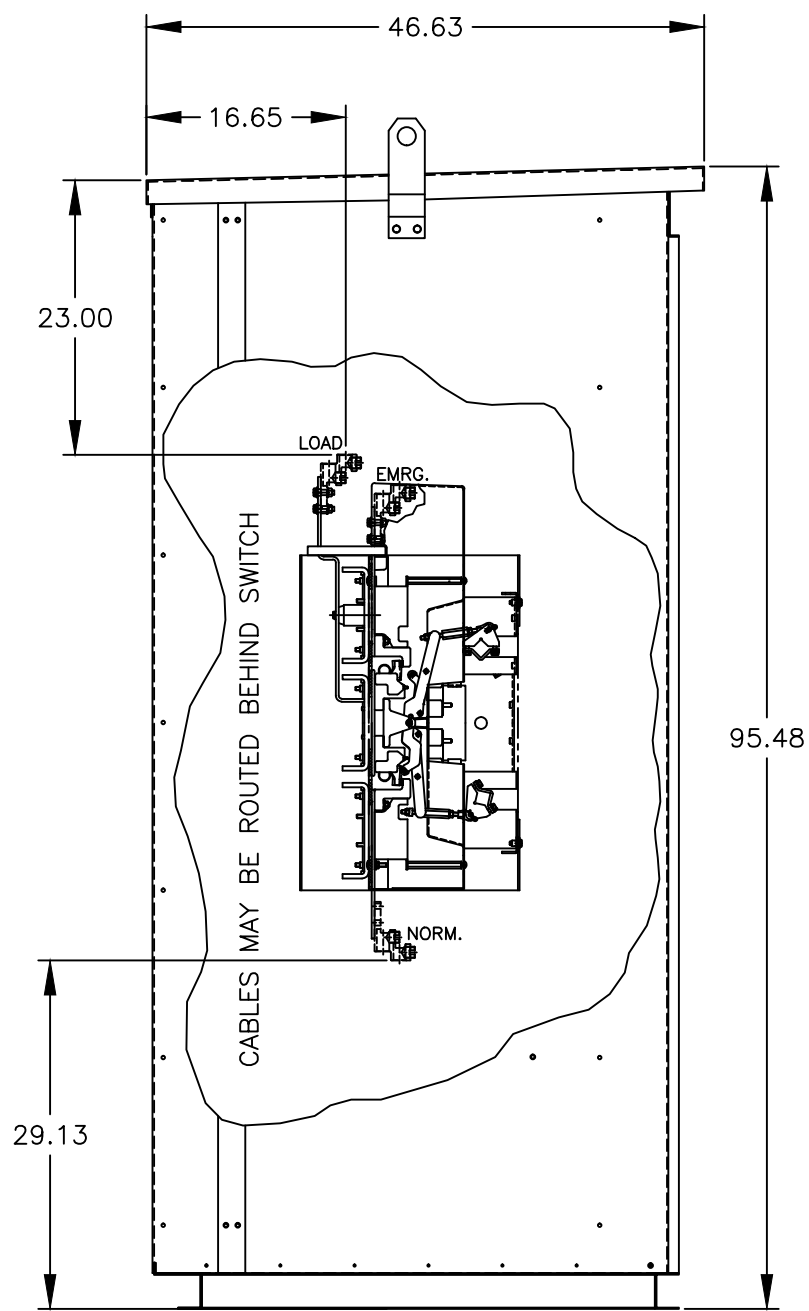
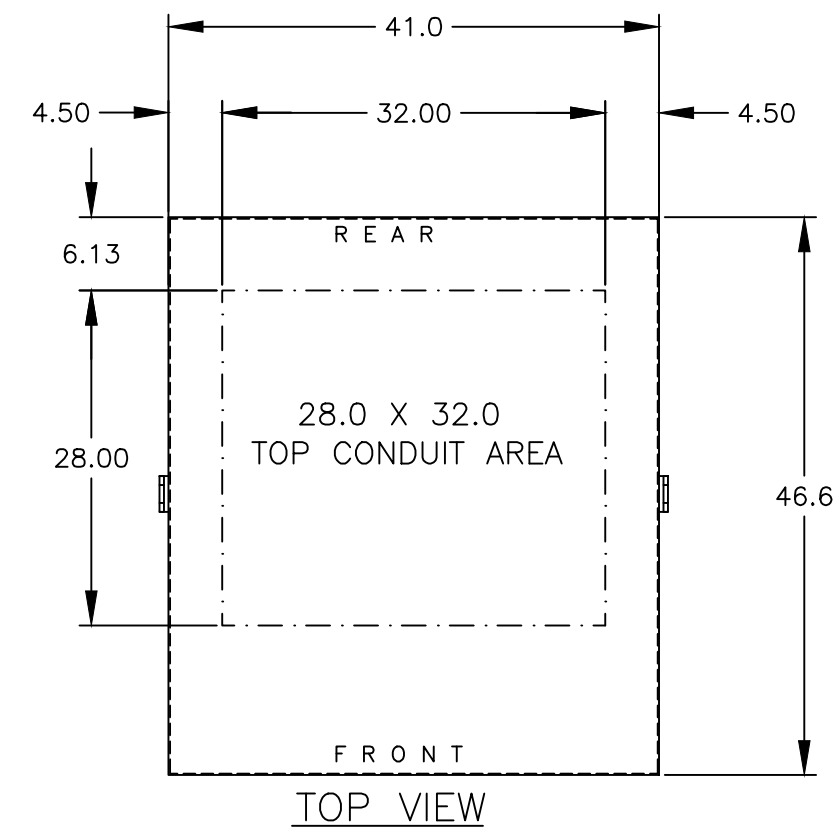

GENERAL NOTES

- TYPE 3R ENCLOSURE. FREE STANDING. FLOOR MOUNTED. CODE GAUGE FORMED FRAME CONSTRUCTION.
- N.E.C. STD. GAUGE INTERIOR PAN TYPE DOORS AND REMOVABLE COVERS. EXTERIOR DOORS ARE SUPPLIED WITH PADLOCKABLE HANDLES & 3-PT LATCH.
- CONSTRUCTION IS IN ACCORDANCE WITH APPLICABLE REQUIREMENTS OF UL 1008.
- FINISH: TYPE 3R: ANSI 61 GRAY POLYESTER SEMI GLOSS ELECTROSTATIC POWDER. TYPE 3RX: EXTERIOR CONSTRUCTED OF CODE GAUGE TYPE 304 STAINLESS STEEL.
- RECOMMENDED CLEARANCES:
FRONT: 45 INCHES; REAR: NONE
- ALL BUS IS SILVER-PLATED COPPER, BASED ON 1000A PER SQ. IN. DENSITY.
- A FULL RATED NEUTRAL CONNECTION FOR EACH SOURCE AND THE LOAD IS OPTIONAL. WHEN PROVIDED IT IS IN ONE OF THE FOLLOWING FORMATS AS SPECIFIED BY THE CATALOG NO. NEUTRAL TYPE;
A. SOLID (COPPER BUS) NEUTRAL (STANDARD).
B. SWITCHED NEUTRAL POLE (OPTIONAL).
- DESIGNED FOR FRONT ACCESS ONLY.
- FOR SPECIFIED TRANSFER SWITCH, REFER TO OPERATOR'S MANUAL PROVIDED WITH UNIT.
- EXTERIOR VENTS ARE SUPPLIED WITH POLYESTER DUST FILTERS.
- LIFTING PLATES: SECTIONS ARE SUPPLIED WITH LIFTING PLATES. INSPECT PLATES FOR DAMAGE AND TORQUE BOLTS TO 45 FT LBS BEFORE USE. REFER TO ANSI/NEMA PB 2.1 FOR PROPER HANDLING OF EQUIPMENT. AFTER INSTALLATION OF SECTION, REMOVE LIFTING PLATES. REINSTALL BOLTS INTO EXTERIOR HOLES AND TORQUE TO APROX. 20 FT LBS.

CABLING NOTES

- ALL SIZES SUPPLIED STANDARD WITH MECHANICAL (SCREW TYPE) LUGS. (SEE AMP SIZE BELOW)
A. LUG MATERIAL: ALUMINUM ALLOY 6061-T6 WITH ELECTRO TIN PLATED FINISH.
B. SCREW MATERIAL: ALUMINUM ALLOY 6262-T9 WITH ELECTRO TIN PLATED FINISH.
C. UL LISTED, CSA CERTIFIED.
D. LUG SCREW TIGHTENING TORQUE PER UL 486B: 19 FT-LBS.
E. SUITABLE WIRE BENDING SPACE IS PROVIDED. (SEE AMP SIZE BELOW)
- GROUND LUGS ARE PROVIDED STANDARD AS FOLLOWS. (SEE AMP SIZE BELOW)
- CUSTOMER TERMINAL BLOCKS:
FOR 300 SERIES UNITS TB WILL BE MOUNTED ON THE TRANSFER SWITCH FRAME AS INDICATED.

NOTES 2000 AMPS

- SUPPLIED WITH STANDARD MECHANICAL (SCREW TYPE) LUGS ON THE NORMAL, EMERGENCY & LOAD BUS STABS. ONE (1) LUG PER PHASE AND NEUTRAL EACH SUITABLE FOR CONNECTION OF SIX (6) 1/0 -750MCM CU/AL CABLE.
A. SUITABLE WIRE BENDING SPACE IS PROVIDED FOR UP TO SIX (6) 750MCM CABLES PER TERMINAL PER NEC.
- GROUND LUGS ARE PROVIDED STANDARD AS FOLLOWS:
(18) 1/0 - 750MCM CU/AL CABLE

B	255051	TR	BK	5/29/15
SEE ECN				
A	247048	TR	BK	3/4/14
SEE ECN				
-	246007	TR	WK	12/27/13
ISSUE				

PROJECT NAME:		REV. TO SHEET	ECN NO.	BY	APP.	DATE
OUTLINE MOUNTING						
G3ATS 2000 AMPS FRONT CONNECTED, LIFTING EYES						
TYPE 3R/3RX SECURE 96 X 41 X 47						
BY	DATE	MANUFACTURING TOLERANCES TO BE IN ACCORDANCE WITH ASCO PROCEDURE MP-1-003. FOR PLASTIC PARTS SEE MP-1-055		ASSEM. REF. NO.	COMPUTER GENERATED DRAWING	
DRAWN BY	TR	12/27/13			SCALE 1/16" = 1" SIZE DS	
CHECKED	BK	12/27/13	PROPERTY OF ASCO POWER TECHNOLOGIES. USE PERMITTED FOR OUR WORK ONLY. ALL RIGHTS OF DESIGN OR INVENTION ARE RESERVED.		DWG. NO.	
PROJECT APPROVAL	BK	12/27/13			1001395-002	
FINAL APPROVAL					DRAWING B	SHEET 1 OF 1
			ASCO Power Technologies, L.P. FLORHAM PARK, NEW JERSEY 07932 U.S.A.		ECN NO. 255051	

EQUIPMENT STORAGE REQUIREMENTS

Equipment provided by Schneider-Electric and/or ASCO Power Technologies that is stored for a short-term duration (i.e., days to weeks) or long-term duration (i.e., months to years), must be kept in a cool, dry, temperature-controlled environment. Storage of equipment in open warehouses, locations without proper temperature and humidity control, and/or outdoor storage is not acceptable without the utilization of heating elements, thermostats, humidistats, and protection from weather and dirt. Failure to comply may result in moisture ingress and/or condensation to form resulting in rusting and or corrosion, component and/or equipment failure and replacement, and/or nullification of any manufacturer warranty.

For **General Instructions for Proper Handling, Installation, Operation, and Maintenance of Deadfront Distribution Switchboards Rated 600 Volts or Less**, refer to [ANSI NEMA PB 2.1-2013](#)

Copies of the following documents should be included on the submittals, depending on the units that are on the proposal:

For ASCO Power Technology's **Switchgear and Switchboards**, refer to Instruction Bulletin **381333-393**.

For Schneider-Electric/Square D's **Power Zone 4 (PZ4) Switchgear**, refer to Instruction Bulletin **80298-002-09**.

For Schneider-Electric/Square D's **Power Zone 4 (PZ4) NEMA 3R Walk-In Switchgear**, refer to Instruction Bulletin **80298-156-02**.

For Schneider-Electric/Square D's **Quality, Efficient, Delivery" (QED2) Switchboard**, refer to Instruction Bulletin **80043-055-14**.

For Schneider-Electric/Square D's **Masterclad Metal-Clad Indoor Switchgear**, refer to Instruction Bulletin **6055-30**.

Limited Warranty

Series 150, 200, 300 and 4000 Power Transfer Switches

This Warranty is given ONLY to purchasers who buy for commercial or industrial use in the ordinary course of each purchaser's business.

General

ASCO Power Technologies, LP products and systems are in our opinion the finest available. We take pride in our products and are pleased that you have chosen them. Under certain circumstances we offer with our products the following Limited Guardian Warranty Against Defects in Material and Workmanship.

Please read your Guardian Warranty carefully. This Warranty sets forth our responsibilities in the unlikely event of defect and tells you how to obtain performance under this Warranty.

Limited Warranty Against Defects in Material and Workmanship:

Product Description	Series	Catalog Code
Automatic Transfer Switch	150, 200	1ATS, 2ATS
	300	3ATS, 3ADTS
	4000	4ATS, 4ADTS, 4ACTS
Non-Automatic Transfer Switch (Electrically Operated)	300	3NTS, 3NDTS
ASCO Lighting Control Panels	4000	4NTS, 4NDTS, 4NCTS
Manual Transfer Switch	300	3MTS, 3MTQ, 3MUQ, 3MPQ, 3MGQ, 3MGDQ, 3MTDQ
Service Entrance Transfer Switch (SEATS)	300	3AUS, 3ADUS, 3APS, 3ARS, 3MUS
Power Transfer Load Center (PTLC)	300	300L
Quick Connect Panels	300	3QCN, 3QCU, 3QCD
Electrically Operated Bypass Switch	4000	4ATE, 4NTE, 4ADTE, 4NDTE

Limited Warranty

ASCO warrants that the ATS will be free from defects in material and workmanship and will conform to ASCO's standard specifications for the ATS for a period of twenty four (24) months from date of product shipment from ASCO (the "Warranty Period"). This Limited Warranty does not extend to subsequent owners of the structure during the Warranty period.

Terms of Warranty

The foregoing Limited Warranty is conditioned upon user's compliance with the following:

1. The ASCO Power Transfer Switch is installed in accordance with ASCO specifications and state and local codes and standards by an electrician licensed in the state of installation.
2. The ASCO Power Transfer Switch is maintained in accordance with ASCO instructions and used under normal conditions for the purposes intended by ASCO.

All warranty field-related repairs, replacements or adjustments must be made by ASCO Services Inc. or its duly authorized representative.

Optional Available Extended Warranty

Optional extended warranty coverage may be purchased from ASCO for a specified fee at the time of the original sale. If purchased, Warranty period shall be extended up to an additional thirty - six (36) months beyond the standard twenty - four (24) months to provide up to five (5) year coverage applicable to the above referenced products, except for 3AUS, 3APS, and 3ARS products where the warranty period for the circuit breaker shall be limited to 24 months from date of shipment from ASCO. The length of optional extended coverage shall be reflected on the ASCO invoice and/or order acknowledgement document.

**Warranty Extends
To First Purchaser
for Use,
Non-Transferable**

This Warranty is extended to the first person, firm, association, or corporation for whom the ASCO product specified herein is originally installed for use (the "user") in the fifty United States or Canada. This Warranty is not transferable or assignable without the prior written permission of ASCO.

**Assignment of
Warranties**

ASCO assigns to user any warranties which are made by manufacturers and suppliers of components of, or accessories to, the ASCO product and which are assignable, but ASCO makes no representations as to the effectiveness or extent of such warranties, assumes no responsibility for any matters which may be warranted by such manufacturers or suppliers and extends no coverage under this Warranty to such components or accessories.

**Drawings,
Descriptions**

ASCO warrants for the period and on the terms of the Warranty set forth herein that the ASCO product will conform to the descriptions contained in the certified drawings, if any, applicable thereto, to ASCO's final invoices, and to applicable ASCO product brochures and manuals current as of the date of product shipment ("descriptions"). ASCO does not control the use of any ASCO product. Accordingly, it is understood that the descriptions are not Warranties of performance and not Warranties of fitness for a particular purpose.

**Warranty Claims
Procedure**

Within a reasonable time, but in no case to exceed thirty (30) days, after user's discovery of a defect, user shall contact ascopowerwarranty@ascopower.com. Subject to the limitations specified herein, an ASCO Services field service representative will repair the non-conforming ASCO product warranted hereunder, without charge for parts, labor, or travel expenses. Warranty coverage will apply only after ASCO's inspection discloses the claimed defect and shows no signs of treatment or use that would void the coverage of this Warranty. All defective products and component parts replaced under this Warranty become the property of ASCO.

**Warranty
Performance of
Component
Manufacturers**

It is ASCO's practice, consistent with its desire to remedy Warranty defects in the most prompt and effective manner possible, to cooperate with and utilize the services of component manufacturers and their authorized representatives in the performance of work to correct defects in the product components. Accordingly, ASCO may utilize third parties in the performance of Warranty work, including repair or replacement hereunder, where, in ASCO's opinion, such work can be performed in less time, with less expense, or in closer proximity to the ASCO product.

**Items Not Covered
By Warranty**

This Warranty does not cover damage or defect caused by misuse, improper application, wrong or inadequate electrical current or connection, negligence, inappropriate on site operating conditions, repair by non-ASCO designated personnel, accident in transit, tampering, alterations, a change in location or operating use, exposure to the elements, water, or other corrosive liquids or gases, acts of God, theft or installation contrary to ASCO's recommendations or specifications, or in any event if the ASCO serial number has been altered, defaced, or removed.

This Warranty does not cover shipping costs, installation costs, external circuit breaker resetting or maintenance or service items and further, except as may be provided herein, does not include labor costs or transportation charges arising from the replacement of the ASCO product or any part thereof or charges to remove or reinstall same at any premises of user.

Repair or replacement of a defective product or part thereof does not extend the original Warranty period.

The products listed in this Warranty are not for use in the control area or any reactor connected or safety applications or within the containment area of a nuclear facility or for integration into medical devices.

Limitations

This Warranty is in lieu of and excludes all other Warranties, express or implied, including merchantability and fitness for a particular purpose.

User's sole and exclusive remedy is repair or replacement of the ASCO product as set forth herein.

If user's remedy is deemed to fail of its essential purpose by a court of competent jurisdiction, ASCO's responsibility for property loss or damage shall not exceed the net product purchase price.

In no event shall ASCO assume any liability for indirect, special, incidental, consequential or exemplary damages of any kind whatsoever, including without limitation lost profits, business interruption or loss of data, whether any claim is based upon theories of contract, negligence, strict liability, tort, or otherwise.

Miscellaneous

No salesperson, employee, or agent of ASCO is authorized to add to or vary the terms of this Warranty. Warranty terms may be modified, if at all, only in writing signed by an ASCO officer.

ASCO obligations under this Warranty are conditioned upon ASCO timely receipt of full payment of the product purchase price and any other amounts due. ASCO reserves the right to supplement or change the terms of this Warranty in any subsequent warranty offering to user or others.

In the event that any provision of this Warranty should be or becomes invalid and/or unenforceable during the Warranty period, the remaining terms and provisions shall continue in full force and effect.

This Warranty shall be governed by, and construed under, the laws of the State of New Jersey, without reference to the conflict of laws principles thereof.

This Warranty represents the entire agreement between ASCO and user with respect to the subject matter herein and supersedes all prior or contemporaneous oral or written communications, representations, understandings, or agreements relating to this subject.

Limited Guardian Warranty

7000 SERIES Power Transfer Switches

This Warranty is given ONLY to purchasers who buy for commercial or industrial use in the ordinary course of each purchaser's business.

General

ASCO Power Technologies, LP products and systems are in our opinion the finest available. We take pride in our products and are pleased that you have chosen them. Under certain circumstances we offer with our products the following Limited Guardian Warranty Against Defects in Material and Workmanship.

Please read your Guardian Warranty carefully. This Warranty sets forth our responsibilities in the unlikely event of defect and tells you how to obtain performance under this Warranty.

Limited Warranty Against Defects in Material and Workmanship:

Product Description	Catalog Code
Automatic Transfer Switch	7ATS, 7ADTS, 7ACTS
Automatic Transfer Bypass - Isolation Switch	7ATB, 7ADTB, 7ACTB
Non-Automatic Transfer Switch (Electrically Operated)	7NTS
Manual Transfer Switch	7MTS
Service Entrance Transfer Switch (SEATS)	7AUS, 7ADUS, 7ACUS, 7AUB, 7ADUB, 7ACUB, 7APS, 7ARS, 7ASUD, 7ASUS, 7ASUB
Power Transfer Load Center (PTLC)	7000L
Automatic Soft Load Transfer Switch & Bypass-Isolation Switch	7ASLS, 7ASLD, 7ASLE, 7ASLB

Terms of Warranty

The following Limited Warranty is conditioned upon user's compliance with the following:

1. The ASCO 7000 Power Transfer Switch is installed in accordance with ASCO specifications and state and local codes and standards by an electrician licensed in the state of installation.
2. The ASCO 7000 Power Transfer Switch is maintained in accordance with ASCO instructions and used under normal conditions for the purposes intended by ASCO.

As provided herein, the ASCO product is warranted to be free of defects in material and workmanship for a period of two, five, and ten years from date of shipment from ASCO provided that the product has been stored in a suitable environment prior to installation; except, however, for 7AUS, 7AUB, 7APS, 7ARS, 7ASLD, 7ASLE, 7ASUD, 7ASUS, 7ASUB and 7000L products, the warranty period for the circuit breaker shall be two (2) years from date of shipment from ASCO. The product shipment date will be determined only from the ASCO bill of lading. If any part or portion of the ASCO product fails to conform to the Warranty within the Warranty period, ASCO, at its option, will furnish new or factory remanufactured products for repair or replacement of that portion or part.

Years 1 – 2: Covers all replacement parts, labor, and travel expenses necessary to remedy the defects in material and/or workmanship. All warranty repair or replacement of said equipment will be performed at ASCO's option at ASCO's service facility location, factory, or user's installation site by ASCO's certified service personnel as deemed most practical by ASCO.

Years 3 – 5: Following expiration of the initial two-year warranty period as detailed herein; parts only determined to be defective will be provided at no charge. Customer is responsible for all other related costs (labor and travel expenses). This does not apply to circuit breakers in 7AUS, 7AUB, 7APS, 7ARS, 7ASLD, 7ASLE, 7ASUD, 7ASUS, 7ASUB and 7000L products.

Years 6 – 10: Following expiration of year five warranty period as detailed herein; main contacts only determined to be defective will be provided at no charge. Customer is responsible for all other related costs (labor and travel expenses).

**Warranty Extends
To First Purchaser
For Use,
Non-Transferable**

Optional extended warranty coverage may be purchased from ASCO for a specified fee at the time of the original sale. If purchased, it shall extend the coverage conditions noted for years 1-2 above up to an additional three (3) years, to provide up to five (5) years of coverage applicable to the above referenced products. Extended warranty coverage must be purchased in one (1) year increments. The length of the optional extended coverage shall be reflected on the ASCO invoice and/or order acknowledgement document. The extended warranty coverage does not affect the standard warranty described above for years 3-10 or the 2-year circuit breaker warranty; those warranty periods will remain the same.

All warranty related repairs, replacements or adjustments must be made by ASCO Services Inc. or its duly authorized representative.

**Warranty Extends
To First Purchaser
For Use,
Non-Transferable**

This Warranty is extended to the first person, firm, association, or corporation for whom the ASCO product specified herein is originally installed for use (the "user") in the fifty United States or Canada. This Warranty is not transferable or assignable without the prior written permission of ASCO.

**Assignment of
Warranties**

ASCO assigns to user any warranties which are made by manufacturers and suppliers of components of, or accessories to, the ASCO product and which are assignable, but ASCO makes no representations as to the effectiveness or extent of such warranties, assumes no responsibility for any matters which may be warranted by such manufacturers or suppliers and extends no coverage under this Warranty to such components or accessories.

**Drawings,
Descriptions**

ASCO warrants for the period and on the terms of the Warranty set forth herein that the ASCO product will conform to the descriptions contained in the certified drawings, if any, applicable thereto, to ASCO's final invoices, and to applicable ASCO product brochures and manuals current as of the date of product shipment ("descriptions"). ASCO does not control the use of any ASCO product. Accordingly, it is understood that the descriptions are not Warranties of performance and not Warranties of fitness for a particular purpose.

**Warranty Claims
Procedure**

Within a reasonable time, but in no case to exceed thirty (30) days, after user's discovery of a defect, user shall contact ascopowerwarranty@ascopower.com. Subject to the limitations specified herein, (i) during the first two years of the warranty, an ASCO service representative will repair the non-conforming ASCO product warranted hereunder without charge for parts, labor, or travel expenses; (ii) during the remainder of the warranty, ASCO will arrange for an ASCO service representative to repair or replace the non-conforming ASCO product warranted hereunder without charge for covered parts, and user shall bear all labor, travel expenses, and shipping charges associated with repair or replacement of the product herein. Warranty coverage will apply only after ASCO's inspection discloses the claimed defect and shows no signs of treatment or use that would void the coverage of this Warranty. All defective products and component parts replaced under this warranty become the property of ASCO.

**Warranty
Performance of
Component
Manufacturers**

It is ASCO's practice, consistent with its desire to remedy Warranty defects in the most prompt and effective manner possible, to cooperate with and utilize the services of component manufacturers and their authorized representatives in the performance of work to correct defects in the product components. Accordingly, ASCO may utilize third parties in the performance of Warranty work, including repair or replacement hereunder, where, in ASCO's opinion, such work can be performed in less time, with less expense, or in closer proximity to the ASCO product.

Items Not Covered By Warranty

This Warranty does not cover damage or defect caused by misuse, improper application, wrong or inadequate electrical current or connection, negligence, inappropriate on site operating conditions, repair by non-ASCO designated personnel, accident in transit, tampering, alterations, a change in location or operating use, exposure to the elements, water, or other corrosive liquids or gases, acts of God, theft or installation contrary to ASCO's recommendations or specifications, or in any event if the ASCO serial number has been altered, defaced, or removed.

This Warranty does not cover shipping costs, installation costs, external circuit breaker resetting or maintenance or service items and further, except as may be provided herein, does not include labor costs or transportation charges arising from the replacement of the ASCO product or any part thereof or charges to remove or reinstall same at any premises of user.

Repair or replacement of a defective product or part thereof does not extend the original Warranty period.

The products listed in this Warranty are not for use in the control area or any reactor connected or safety applications or within the containment area of a nuclear facility or for integration into medical devices.

Limitations

This Warranty is in lieu of and excludes all other Warranties, express or implied, including merchantability and fitness for a particular purpose.

User's sole and exclusive remedy is repair or replacement of the ASCO product as set forth herein.

If user's remedy is deemed to fail of its essential purpose by a court of competent jurisdiction, ASCO's responsibility for property loss or damage shall not exceed the net product purchase price.

In no event shall ASCO assume any liability for indirect, special, incidental, consequential or exemplary damages of any kind whatsoever, including without limitation lost profits, business interruption or loss of data, whether any claim is based upon theories of contract, negligence, strict liability, tort, or otherwise.

Miscellaneous

No salesperson, employee, or agent of ASCO is authorized to add to or vary the terms of this Warranty. Warranty terms may be modified, if at all, only in writing signed by an ASCO officer.

ASCO obligations under this Warranty are conditioned upon ASCO timely receipt of full payment of the product purchase price and any other amounts due. ASCO reserves the right to supplement or change the terms of this Warranty in any subsequent warranty offering to user or others.

In the event that any provision of this Warranty should be or becomes invalid and/or unenforceable during the Warranty period, the remaining terms and provisions shall continue in full force and effect.

This Warranty shall be governed by, and construed under, the laws of the State of New Jersey, without reference to the conflict of laws principles thereof.

This Warranty represents the entire agreement between ASCO and user with respect to the subject matter herein and supersedes all prior or contemporaneous oral or written communications, representations, understandings, or agreements relating to this subject.



Flexible Power Transfer Solutions for Commercial & Industrial Applications

ASCO Power
Technologies™

ASCO SERIES 300
Power Transfer Switches



ascopower.com

Life Is 

Schneider
Electric

ASCO SERIES 300 Automatic Transfer Switches

Power outages impact small and large facilities alike. ASCO SERIES 300 Automatic Transfer Switches offer rugged design and reliable performance to small and mid-size commercial and industrial facilities in packaged solutions that are easy to select, procure, install, and operate.

Every SERIES 300 generator transfer switch is engineered with ASCO's reliability expertise in a package that makes backup power accessible for small and mid-size facilities. Leveraging knowledge derived from a century of critical power transfer experience, each SERIES 300 is backed by the same ASCO technical support and service that solves the most demanding critical power challenges facing facilities today.

Product Details

[Transfer Switch Overview](#)



ASCO's SERIES 300 lineup offers flexible backup power solutions for businesses of every size.

SERIES 300 Automatic Transfer Switches

Designed to Fit Anywhere

The ASCO SERIES 300 product line provides the most compact design of generator power transfer switches in the industry.

Available to mount on walls or floors, all models through 2000 amperes are designed to be completely front-accessible. This permits installation flush against walls while allowing installation of cabling and connections from the front of the switch. Cable entrance plates are standard on 1600 and 2000 amperes units; these allow use of optional side-mounted pull boxes for additional cable bending space.

- 30 through 3000 amperes in compact designs
- Up to 600 VAC, single or three phase
- Listed to UL 1008 - Standard for Safety - Transfer Switch Equipment
- True double-throw operation: The single solenoid design is inherently interlocked to prevent simultaneous connections of two power sources.
- Will not transfer to a dead source - single solenoid operator derives power from the destination source
- Easy-to-navigate 128x64 graphical LCD display with keypad provides LED indicators for switch position, source availability, not-in-auto mode, and alert conditions.
- Integrated, multilingual, user interface for configuration and monitoring
- Available Delayed Transition operation
- Non-automatic operation can be selected without opening enclosure door
- Optional Relay Expansion Module with extra relays for accessory outputs
- Soft keys for test function and time delay bypass
- Emergency source failure alert indication
- Optional Historical Event Log
- Displays statistical ATS monitoring information
- Built-in diagnostic functions
- Password protection to prevent unauthorized actions
- Adjustable delay feature prevents nuisance transfer due to momentary utility power outages and generator dips
- Auxiliary contacts signal position of main contacts - two for normal and two for emergency position
- Standard solid neutral terminals
- Restriction of Hazardous Substances (RoHS) compliant controller
- Standard 2 year warranty. Optional 1, 2, and 3 year extensions

Power Knowledge

[Basic Automatic Transfer Switch Functions](#)



SERIES 300 Automatic Switching Solutions

Automatic and Non-Automatic Transfer Switching

ASCO Transfer Switches are available in both automatic and non-automatic types. Both are electrically operated. For automatic transfer switches, the controller initiates transfer between power sources. For non-automatic transfer switches, a user initiates transfer using local or remote controls.

SERIES 300 non-automatic transfer switches offer the following features:

- Models range from 30 through 3000 amperes, up to 600V
- Source acceptability lights inform operator when sources are available to accept load
- Controller prevents inadvertent operation under low voltage conditions
- Standard in-phase monitor for transferring motor loads between live sources

Power Knowledge

[Non-Automatic and Manual Transfer Switches for Backup Power Applications](#)



Open Transition Transfer Switching

ASCO Transfer Switches are available with a standard, 2-position, open transition models that reliably transfer loads in less than 100 milliseconds. Open transition switches are suitable for a wide range of applications.

- 30 to 3000 amps
- Single-operator switching mechanism prevents simultaneous connection of both sources
- Available In-Phase Monitor can be activated for transferring motor loads

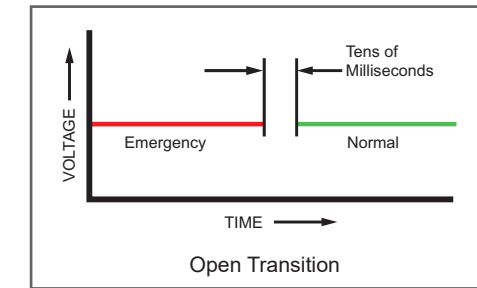

Delayed Transition Transfer Switching

ASCO Delayed Transition Transfer Switches transfer loads between power sources using a timed load disconnect position with an adjustable delay.

- 150 through 3000 amps
- Reliable, field-proven, dual-solenoid operating mechanism
- Mechanical interlocks to prevent simultaneous connection of both power sources
- Adjustable delay for load disconnect - 0 to 5 minutes
- Non-automatic models available in manual operation configuration
- Automatic models available with load shed feature

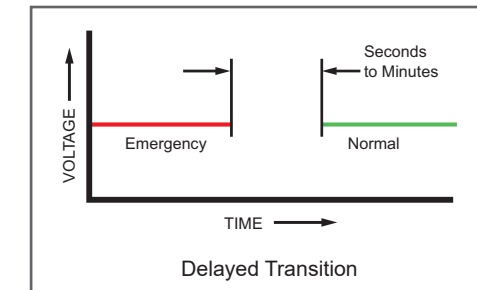

SERIES 300 Group G Controller

The SERIES 300 Group G Controller is reliable and field-proven. It provides all of the voltage, frequency, control, timing, and diagnostic functions required for most emergency and standby power applications.

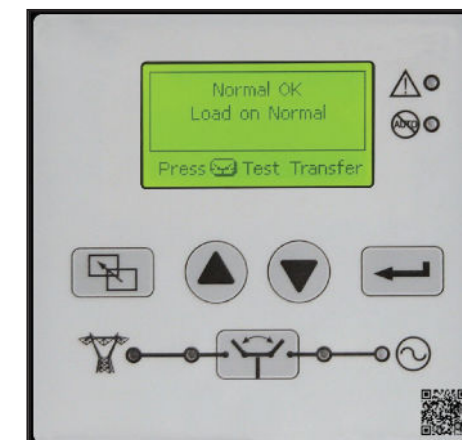

- Touch pad programming
- Displays active timers
- On-board diagnostics
- Password protection
- Voltage and frequency sensing
- Status and control functions

Power Knowledge

[Transition Mode Basics](#)

[Transferring Motor Loads between Power Sources](#)

[Transferring Loads with Zero Power Interruption](#)

Product Details

[Group G Controller](#)

Transfer Switch Communications and Metering

Options to Customize Functionality and Increase Value

Product Details

[5300 SERIES Annunciators](#)

Remote Annunciation

Monitor Power Equipment Status from Anywhere

Monitoring and control transfer switches from across the room, building, or from Internet.

5310 – LED annunciator – Single ATS

5350 – LED annunciator – up to 8 ATSS



Product Details

[5140 Connectivity Module](#)

Communication

Turn Transfer Switches into Power Information Portals

5140 Connectivity Module – Makes status and power information from a single switch available to via ModBUS, SNMP, and web pages.

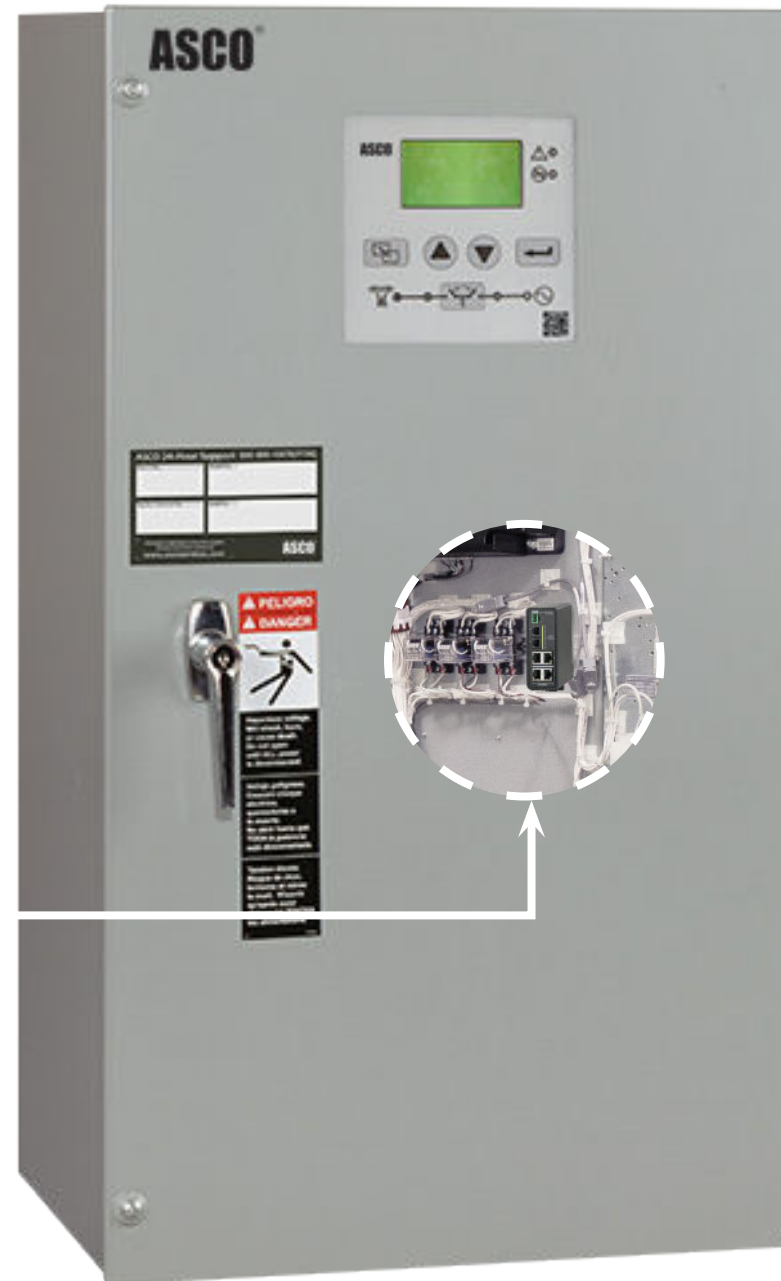

Metering

Transfer Switches are the Perfect Place to Monitor Power Flow, Power Conditions, and Power Events

5210 Power Meter – Provides deeper insight into circuit status and conditions.

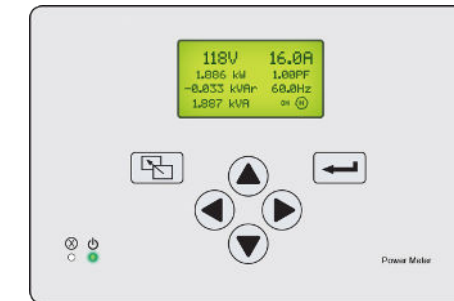

Product Details

[5210 Power Meter](#)

SERIES 300 Optional Accessories

Communications	
11BE	Feature Bundle. Programmable engine exerciser with seven independent routines run the generator with or without loads, on a daily, weekly, bi-weekly, or monthly basis. Controlled from the user interface keypad. <ul style="list-style-type: none"> Event log display shows the event number, time and date, type and reason (if applicable). Stores up to 300 events RS485 Communication Port enabled common alarm output contact On three-phase systems, Accessory 11BE enables line-to-line voltage imbalance sensing and three-phase sensing capabilities for the Emergency power source as well as the Phase Rotation checking for both power sources.
18RX	Relay Expansion Module provides accessory relays and includes one Form C contact for normal source availability (18G), and one Form C contact for emergency source availability (18B) (contact rating 5 amperes @ 30 VDC or @ 125 VAC resistive) (100 ma, 4 VDC min) Additional output relay is provided the default is to indicate a common alarm.
72EE	Connectivity module provides remote monitoring and control capabilities and includes accessory 11BE feature bundle
Environment and Power	
44A	Strip heater with thermostat for cold environment to prevent internal condensation and icing. External 120-volt AC power source required.
44G	Strip heater with thermostat, wired to load terminals on 208-240, 360-380, 460-480, 550-600 volt models. Contains wiring harnesses for all transfer switch sizes.
1UP	UPS back up power runs controller and LCD display for 30 seconds without AC power
Extension Harness	
37B	Six-foot extension harness for open type units to accommodate customer mounting of controls and switch
37C	Nine-foot extension harness for open type units to accommodate customer mounting of controls and switch
Indicators	
62W	Audible alarm with silencing feature to signal transfers to emergency. (For D-frame models, may require oversize enclosure depending on accessory combination).
Customer Control Circuits	
30A	Load-shed circuit initiated by opening of a customer-supplied contact (Open Transition model only)
30B	Load-shed circuit initiated by removal of customer-supplied control voltage (Open Transition model only)
30AA	Load-shed circuit initiated by opening of a customer-supplied contact (Delayed Transition model only)
30BA	Load-shed circuit initiated by removal of customer-supplied control voltage (Delayed Transition model only)
Surge Protection	
73	Surge suppressor rated 65 kA
Metering	
23GA, 23GB	Load Current Metering card measures either single or three-phase load current. Not available with Power Meter option 135L. Use 23GA for Single-Phase, 23GB for Three-Phase.
135L	Power Meter on load side (includes shorting block and current transformers). Not available with Load Current Metering options 23GA or 23GB.

Field Conversion Kits

Kit No.	Description
935147	Advanced Function Bundle Retrofit Kit (11BE) - See above accessory 11BE description for details.
935148	REX Module with Source Availability Contacts (Acc. 18RX)
935149	UPS to allow controller to run for 30 seconds minimum without AC Power (Acc. 1UP)
935150	1/3 Phase load current sensing card only (Acc. 23GA/GB)
K613127-001	Strip Heater (125 watt) 120 volt (Acc. 44A)
K613127-002	Strip Heater (125 watt) 208-480 volt (Acc. 44G)
948551	Quad-Ethernet Module (Acc. 72EE)
K609027	Cable Pull Box (1600-2000 amperes)

Withstand and Closing Ratings

FRAME	RATINGS AMPERES	CURRENT LIMITING FUSES				SPECIFIC BREAKER		
		480V MAX.	600V MAX.	MAX. SIZE, AMPS	CLASS	240V MAX.	480V MAX.	600V MAX.
D	30	100kA	-	300	J	22kA	22kA	10kA
		200kA	35kA	200	J			
		35kA	35kA	200	RK1			
	70-100	35kA	35kA	200	RK1	150kA	85kA	25kA
		200kA	35kA	200	J			
	150	35kA	35kA	200	RK1	150kA	85kA	25kA
		200kA	35kA	200	J			
	200	200kA	35kA	200	J	200kA	85kA	14kA
		35kA	35kA	200	RK1			
	230	100kA	-	300	J	200kA	85kA	14kA
E	260, 400	200kA	-	600	J	65kA	42kA	22kA
J	150, 200, 260	200kA	200kA	600	J	200kA	200kA	42kA
				800	L			
	400	200kA	200kA	600	J	65kA	50kA	42kA
				800	L			
	600	200kA	200kA	600	J	65kA	85kA	42kA
				800	L			
H	800-1200*	200kA	200kA	1200	L	65kA	150kA	65kA
G	1600-2000	200kA	200kA	2500	L	85kA	85kA	85kA
	2600-3000	200kA	200kA	4000	L	125kA	125kA	100kA
	4000	200kA	200kA	5000	L	100kA	100kA	100kA

Notes:

* Front connection only

All units are RMS Symmetrical Amperes

All Withstand and Closing Rating values are tested in accordance with UL 1008. See **ASCO Publication 1128** for more information.

Application requirements may permit higher WCR for certain switch sizes.

Power Knowledge

 [UL 1008 Transfer Switch Withstand and Closing Ratings](#)

 [Performance Testing for Transfer Switches](#)

Additional SERIES 300 Product Information

Transfer Switches and Panels	Controls	Technical Information
Manual Transfer Switch	Group G Controller	Withstand and Closing Ratings
Manual Transfer Switch with Quick Connects		Weights and Dimensions and Ordering Info
Quick Connect Power Panel		Drawings
Dual Purpose Quick Connect Power Panel		Wiring Diagrams

SERIES 300 Manual Transfer Switching and Quick Connection Solutions

ASCO SERIES 300 Manual Transfer Switching and Quick Connection Solutions offer reliable service and application flexibility for a wide range of facilities.

Manual Transfer Switches



- Three-position, easy-to-use center-off switch
- Compact design - easy to install and maintain
- Designed to handle demands of motors and inrush currents

Power Knowledge

[Differences Between Manual, Non-Automatic, & Automatic Transfer Switches](#)

Product Details

[SERIES 300 Manual Transfer Switch](#)

Quick Connect Panels



- Listed to UL 1008 Transfer Switch Accessory standard
- Utilizes standard Cam-Lok™ receptacles for quick connections
- Standard Type 3R construction is weatherproof with or without cable
- Utilizes standard Series 16 Single Pole quick connect receptacles

Power Knowledge

[NEC Requirement for Permanent Manual Switching Means](#)

Product Details

[SERIES 300 Quick Connect Power Panel](#)

Manual Transfer Switches with Quick Connects



- The ASCO SERIES 300 Manual Transfer Switch with Integrated Quick Connects provides a total temporary power connection and transfer solution
- Enables connection and control of a temporary or portable generator
- Provides a complete UL 1008-listed solution in a single unit

Product Details

[SERIES 300 Manual Transfer Switch with Quick Connects](#)

Dual-Purpose Manual Transfer Switches with Quick Connects



- Provides both supplemental backup power and load testing connectivity through a single device.
- Listed to UL 891 by ETL
- Utilizes standard Series 16 Single Pole quick connect receptacles

Product Details

[SERIES 300 Dual Purpose Quick Connect Power Panel](#)

Life Is On

Schneider
Electric™

ASCO Power Technologies - Global Headquarters
160 Park Avenue
Florham Park, NJ 07932
Tel: 800 800 ASCO

www.ascopower.com
customercare@ascopower.com



Power Transfer for Mission-Critical Applications

ASCO Power
Technologies™

ASCO 7000 SERIES
Low-Voltage Transfer Switches



ascopower.com

Life Is On 

Schneider
Electric 

ASCO 7000 SERIES Power Transfer Switches

ASCO 7000 SERIES Power Transfer Switches provide unmatched reliability and sophisticated control for the most demanding mission-critical backup power needs.

ASCO 7000 SERIES Transfer Switches are widely used in the most complex mission-critical hospital and healthcare facilities, enterprise and cloud-based data centers, telecommunication networks, water treatment plants, and any facility that requires the highest levels of power availability.

Every 7000 SERIES transfer switch is engineered-to-order to optimize switch functionality and provide facilities with the best solution for their specific application, and custom-engineering is available to meet any transfer switching need.

Backed by industry-leading technical support and service knowledge derived from a century of critical power switching experience, the 7000 SERIES solves the most demanding critical power challenges facing facilities today.

Power Knowledge

[Transfer Switch Overview](#)

7000 SERIES Power Transfer Switches

ASCO Power Transfer Switches are the standard of the industry. High-speed transfer of loads between alternate sources of power, regardless of ampacity, is achieved using a reliable, field-proven solenoid operating mechanism.

- Listed to UL 1008 Transfer Switch Equipment and Certified to CSA 22.2, No. 178
- Qualified and certified to IEC 60947-6-1, optional CE mark
- Rated up to 600 VAC, 30 through 4000 amps
- 3 to 18-Cycle Withstand and Closing Rating Standard, 30-Cycle WCR Optional
- High Withstand and Closing Rating, including Short-Time Ratings, support breaker coordination
- Solid, switched, or overlapping neutral configurations
- Front-replaceable main and arcing contacts on 800-4000 amp models
- Central terminal block for control connections on 260-4000 amp models
- Four auxiliary contacts: two closed when switch is in normal position and two closed when switch is in emergency position
- Local/remote communications to ASCO communication products
- Comprehensive 2, 5, or 10 year warranty

Power Knowledge

[Basic Automatic Transfer Switch Functions](#)



7000 SERIES Power Switching Solutions

Automatic and Non-Automatic Transfer Switching

ASCO Transfer Switches are available in automatic and non-automatic types. For automatic transfer switches, the controller initiates transfer. For non-automatic transfer switches, a user initiates transfer between power sources using local or remote switches. ASCO 7000 SERIES Transfer Switches offer the following features:

- Rated up to 600VAC, sizes from 30 through 4000 amps
- Controller prevents inadvertent operation under low voltage conditions
- Low control circuit currents allow for long distances between remotely control switches and transfer switches
- Standard in-phase monitor for transferring motor loads
- Non-automatic models provide source acceptability lights to inform operator when sources are available to accept load

Power Knowledge

[Non-Automatic and Manual Transfer Switches for Backup Power Applications](#)



Four Pole, Non-Automatic, Electrically-Operated 400 Amp Switch in a Type 1 Enclosure

Open Transition Transfer Switching

ASCO Transfer Switches are available with a standard, 2-position, open transition models that reliably transfer loads in a "break-before-make" sequence in less than 100 milliseconds. Open transition switches are suitable for a wide range of applications.

- 30 to 4000 amps
- Single-operator switching mechanism prevents simultaneous connection of both sources
- Available In-Phase Monitor can be activated for transferring motor loads

Delayed Transition Transfer Switching

ASCO Delayed Transition Transfer Switches transfer loads between power sources using a timed, load, disconnect position with an adjustable delay. Applications include older variable frequency drives, rectifier banks, and load management applications.

- 150 through 4000 amps
- Mechanical interlocks to prevent interconnection of both sources
- LED Indicator for load disconnect position
- Adjustable time delay for load disconnect position

Closed Transition Transfer Switching

ASCO Automatic Closed Transition Transfer Switches overlap the normal and emergency source to transfer without power interruption. The switch transfers in a make-before-break sequence if both power sources are within acceptable parameters. Control logic continuously monitors source conditions and automatically selects open or closed transition according to real-time values.

- Available 150 through 4000 amps
- Closed Transition Transfer occurs passively without directly controlling the engine-generator set
- Overlap time is less than 100 milliseconds
- Indications for failure-to-synchronize and extended parallel time

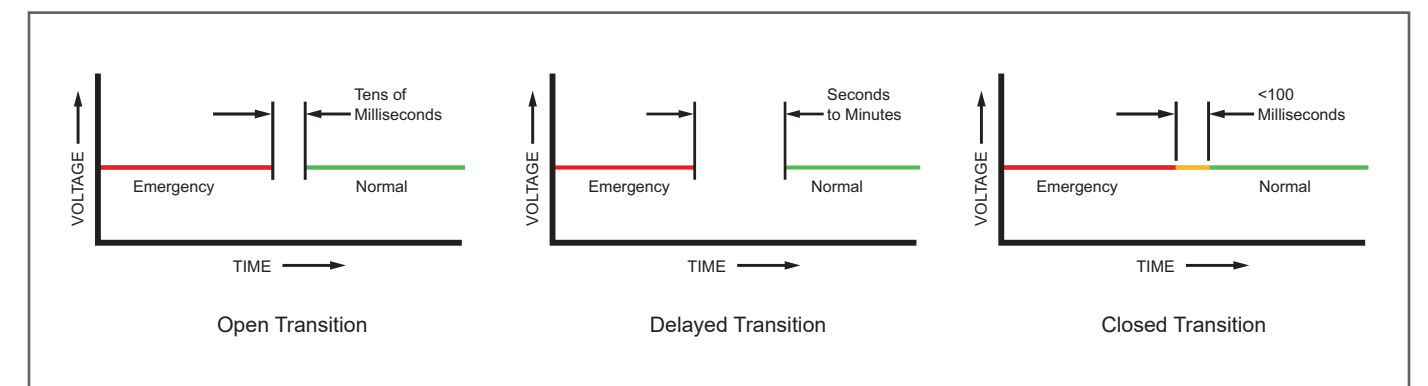

Power Knowledge

[Transferring Motor Loads between Power Sources](#)

[Transition Mode Basics](#)

[Transferring Loads with Zero Power Interruption](#)

7000 SERIES Bypass-Isolation Switches

Bypass-Isolation Automatic Transfer Switches

ASCO Bypass-Isolation Automatic Transfer Switches are available in open transition, closed transition, and delayed transition designs. The bypass-isolation features allow the primary automatic transfer switch to be inspected, tested, and maintained without interrupting power to the load. They also provide redundant power transfer if the ATS is disabled or removed from service.

- 150 to 4000 amps
- Bypass switch and transfer switch have identical electrical ratings
- Mechanical interlocks prevent unintended operation
- Bypass contacts carry current only during bypass operation
- Draw-out design eases transfer switch maintenance
- Bypass switch is rated for use as a 3-position manual transfer switch
- Bypass and isolation functions require only two permanently mounted operating handles
- Mechanical indicators show bypass and transfer switch positions
- Shallow depth, front-connected, or rear-connected designs

Power Knowledge

[3D Bypass Switch Animation](#)

Product Details

[Bypass-Isolation Transfer Switches](#)

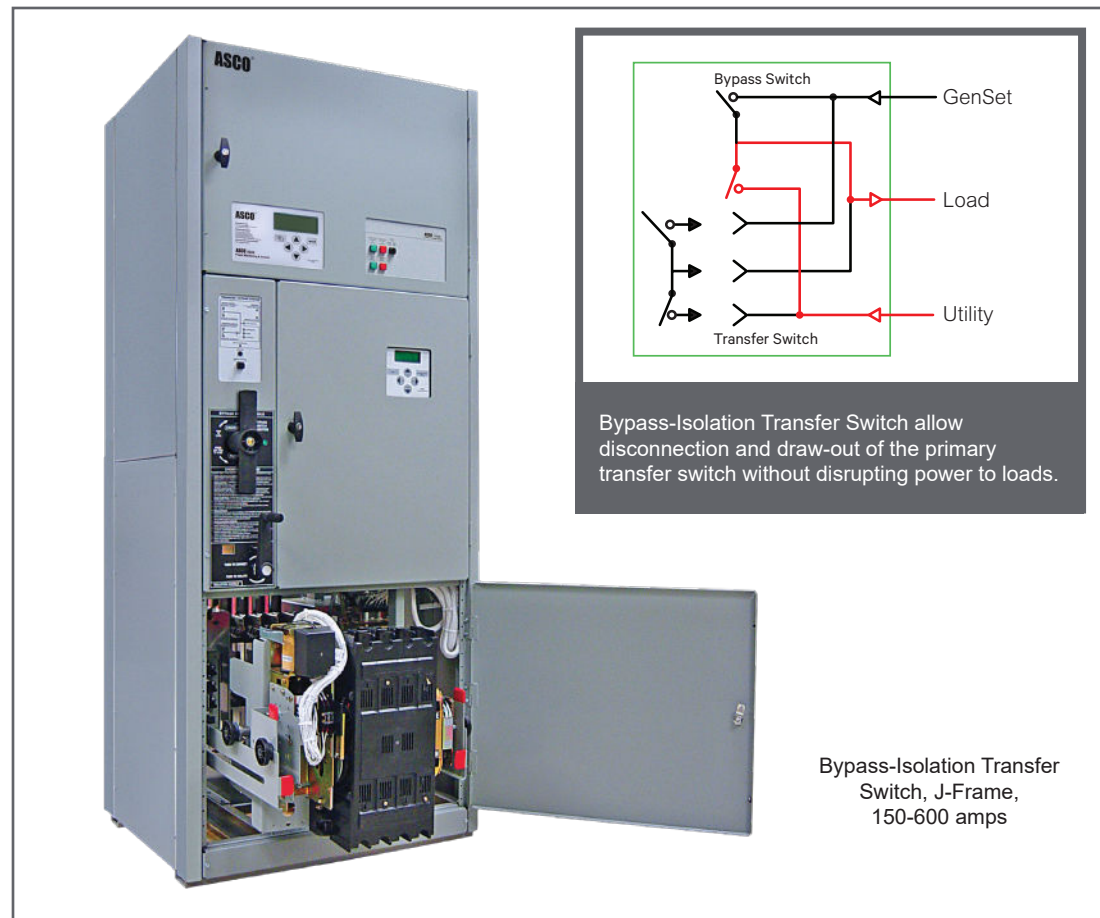

Bypass-Isolation Transfer Switch, J-Frame, 150-600 amps

7000 SERIES Service Entrance Switches

Service Entrance Power Transfer Switches

The ASCO Service Entrance Power Transfer Switch combines automatic power switching with a disconnect and over-current protection device for the utility source. These switches are installed at facilities that have a single utility feed and a single emergency power source. A circuit breaker serves as the utility disconnect. This product is available up to 600V and 4000 amps in Standard, Delayed, Closed Transition, and Bypass-Isolation configurations.

- Available from 70 to 4000 amps, up to 600V
 - 70 - 400 amp listed to UL 1008
 - 600 - 4000 amp listed to UL 891
- UL 1008 Listed transfer mechanism
- Disconnect and over-current protective device on the utility source. 70 to 2000 amp models use molded case circuit breakers; 2500 to 4000 amp models use insulated case circuit breakers.
- Disconnect links on Neutral and Ground
- Internet-enabled monitoring and control

Power Knowledge

[Applications for Service Entrance Automatic Transfer Switches](#)

Product Details

[Service Entrance Transfer Switches](#)



Service Entrance Breaker

Custom-Engineered Transfer Switches

Optimized Solutions for Mission-Critical Performance

Create an exact power control solutions by integrating service equipment and protective devices and incorporating distribution equipment while accommodating unique application requirements. Custom engineered devices can save space, reduce delivery times, streamline installation and commissioning, enhance quality control, and reduce overall cost.

Integrated Distribution Breakers

Common distribution breaker applications include:

- Panels to house molded case circuit breakers
- Insulated case circuit breakers, with or without drawout capability
- Manually or electrically operated circuit breakers

Automatic Transfer Switchboard

- Connects multiple automatic transfer switches together in a common switchboard
- Two ASCO 2000 ampere automatic bypass-isolation transfer switches
- Circuit breakers on the normal and load sides of each switch
- An ammeter and voltmeter are also located on the load side of each switch

Three Source System

- Sequential transfer switches select between alternative power sources
- Normal, emergency, and/or load circuit breakers
- Protective relays, when required
- Available metering for normal, emergency

Power Knowledge

[Benefits of Custom-Engineered Transfer Switches](#)



Transfer Switches can be custom-engineered to integrate service entrance equipment, distribution equipment, and more.



“The maintenance is top notch and the technical support is amazing. ASCO service techs ... do what's right for the hospital, not just the job.”

Mark Y., Electrical Management Supervisor

Additional Available Custom Features

These examples are just a few of the configurations and features available through custom-engineered solutions. Additional possibilities include:

- Custom Metering
- Bus Riser
- Source Fusing
- Utility-Specified Compartments

For more information, contact an authorized ASCO Power Technologies Representative.

7000 SERIES Controls and Indicators

Group 5 Controller

The 7000 SERIES Group 5 Controller is reliable and field-proven. It provides all of the voltage, frequency, control, timing, and diagnostic functions required for most emergency and standby power applications.

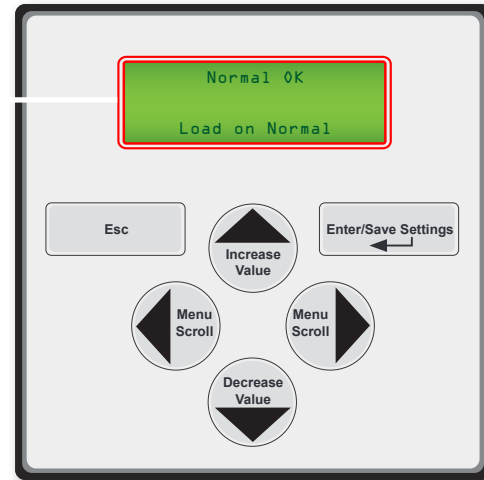

- Touch pad programming
- Displays active timers
- On-board diagnostics
- Password protection
- Voltage and frequency sensing
- Status and control functions

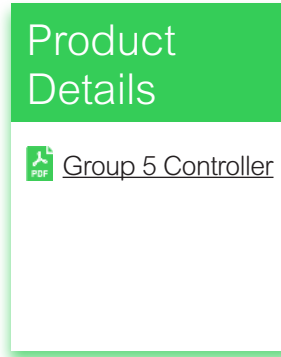

Source Status

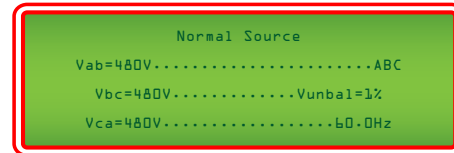

In-phase Transfer Status

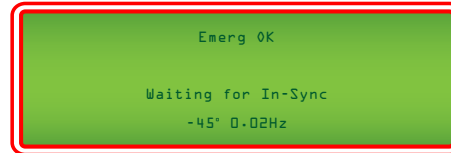

Voltage and Frequency Settings

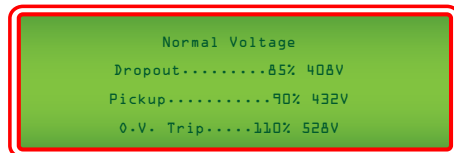

Engine Exerciser

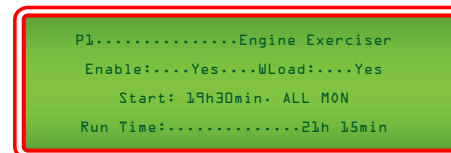

Control Switches and Indicating Lights

- Switch position indicating lights
- Source acceptability indicator lights
- Three-position selector switch:
 - Automatic: Normal position
 - Test: Simulate normal source failure
 - Reset Delay Bypass: Bypass transfer and re-transfer time delays



Control Switches and Indicating Lights for Closed Transition Switches

Additional controls and Indicators for:

- *Extended Parallel Time* - Provides visual indication when the pre-set extended parallel time has been exceeded. The controls automatically open the emergency or normal main contacts. Separate contact also available to shunt trip external breaker.
- *Failure To Synchronize* - Visually displays a failure to synchronize alarm if the time delay settings are exceeded during closed transition transfer operation.
- *Transfer Switch Locked Out* - Prevents transfer in either direction if the extended parallel time is exceeded.
- *Alarm Reset* - Resets extended parallel and failure to synchronize alarms.
- *Closed Transition Bypass* - Pushbutton allows transfer between sources in an open transition mode.

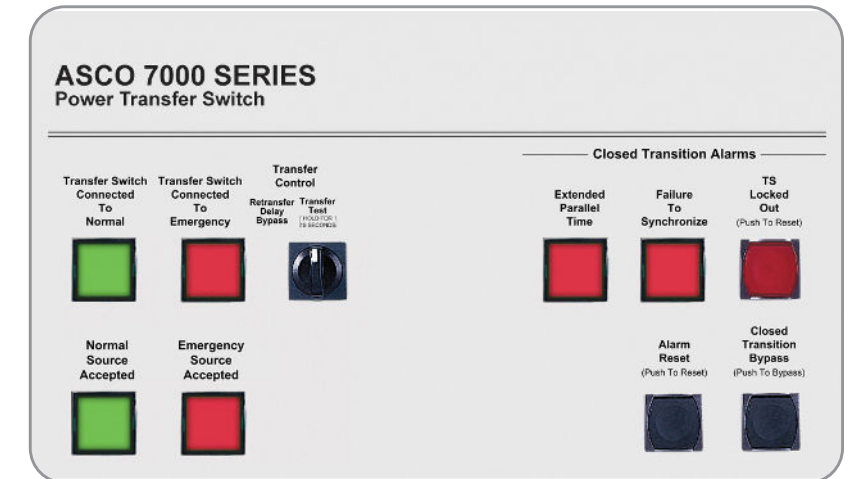

Transfer Switch Communications and Metering

Options to Customize Functionality and Increase Value

Product Details

[5300 SERIES Annunciators](#)

[5700 SERIES Annunciator](#)

Remote Annunciation

Monitor Power Equipment Status from Anywhere

Monitoring and control transfer switches from across the room, building, or from Internet.

5310 – LED annunciator – Single ATS

5350 – LED annunciator – up to 8 ATSs

5705 – Interactive CPMA-based graphical annunciator – up to 8 ATSs



Product Details

[5170 Connectivity Module](#)

[5701 Gateway](#)

Communication

Turn Transfer Switches into Power Information Portals

5170 Connectivity Module – Makes status and power information from a single switch available to via ModBUS, SNMP, and web pages.

5701 8 Device Gateway – Provides centralized monitoring of up to 8 power devices through a transfer switch. Connects generators, transfer switches, load banks, and more to web pages for increased monitoring and control.

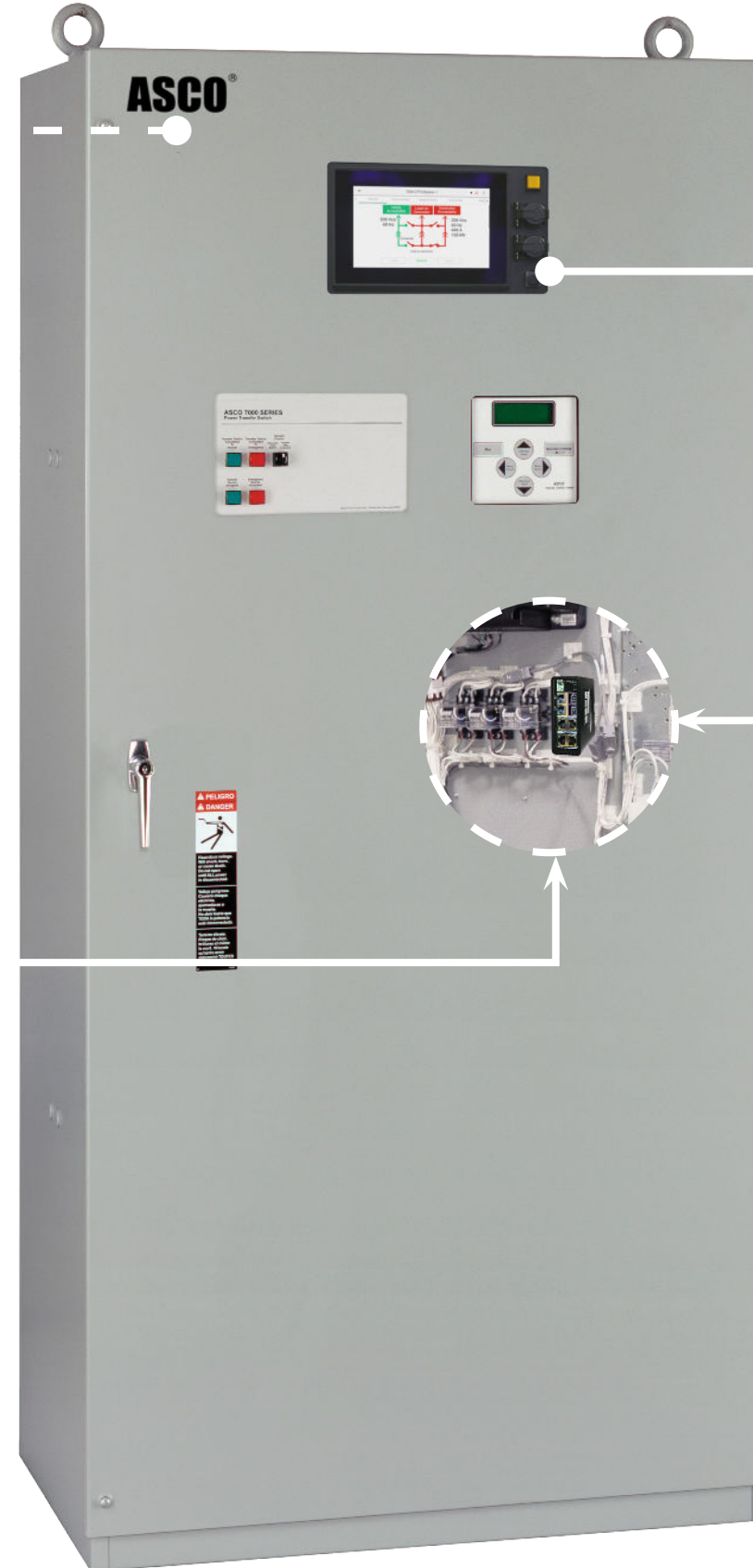

Touch Display Interface

Advanced Graphical Display and Control

5370 – Graphically displays information from transfer switches and power devices. Touch display transfers, re-transfers, initiates engine start, and configures transfer switch settings.

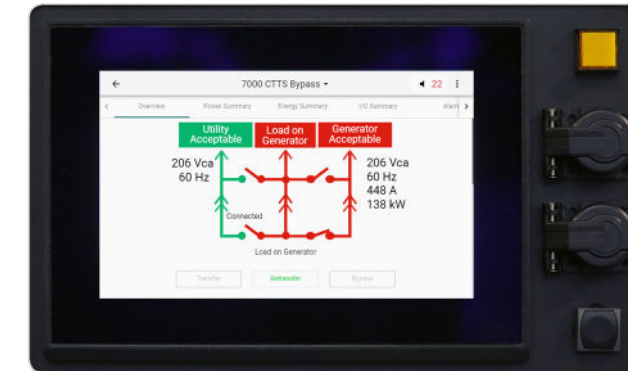

Product Details

[5370 Touch Display Interface](#)

Metering

Transfer Switches are the Perfect Place to Monitor Power Flow, Power Conditions, and Power Events

5210 Power Meter – Provides deeper insight into circuit status and conditions.

PowerLogic PM 8000 – Schneider Electric's compact, high-performance, power meter simplifies power quality and maximizes versatility.



Product Details

[5210 Power Meter](#)

[PowerLogic PM 8000](#)

7000 SERIES Optional Accessories

Time Delays and Extended Control Power

1G1	Auxiliary power connections provide for external 24VDC source to power control panel and power manager/meter when normal and emergency sources are not present or the switch is in isolation mode. Allows for use of full range of extended engine starting time delay feature 1C (0-60min 59 sec).
1GB1	Same as accessory 1G1 except using 120-volt AC external input.
1PS1	Extended control power ride-through (approx. 25 seconds) for Group 5 ATS controller and select communications and metering accessories, e.g. Acc. 72EE2, 72FC, 135L, etc.

Manual Controls for Automatic Transfer Switches

6DL	Selector switch for automatic/manual re-transfer to normal. Automatic bypass if emergency fails.
------------	--

Indicators

18B	Two-pole, double-throw contacts operate when emergency source voltage is present at transfer switch terminals.
18G	Two-pole, double-throw contacts operate when normal source voltage is present at transfer switch terminals.
99	"Push-to-Test" feature on all pilot light indicators.

Customer Control Circuits

30A	Load-shed circuit initiated by opening of a customer-supplied contact.
30B3	24 VDC load-shed circuit initiated by removal of customer-supplied control voltage. (6, 12, 48, 120 VDC and 120 VAC also available).
31Z	Selective load disconnect control contacts that operate with time delay prior to and/or after load transfer and re-transfer.

Communications

72EE2	Offers remote Ethernet monitoring via open Mod bus and SNMP protocols, email notifications and embedded monitoring web pages. (Catalog No. 5170 for stand-alone product).
107G	Provides Building Monitoring Systems with transfer switch, bypass, and load power metering information in Modbus TCP/IP, BACnet IP, and SNMP Protocols. Compatible with any Accessory 150 Technology Package or 72EE2.

Surge Protection : ASCO 430 TVSS, rated 200 kA per phase

73CC1	Normal source protection. (3Ø, 4wire WYE)
73CC2	Emergency source protection. (3Ø, 4wire WYE)
73CC3	Load side protection. (3Ø, 4wire WYE) Note: Other distribution voltages and kA ratings available.

Special Applications

29A	Manual selector switch for designating one of two utility feeds as the preferred source.
111A	Generator - to - Generator for Standby Applications
125A	Seismic Certification to International Building Code for electrical equipment
131	Certification of compliance with the American Recovery & Reinvestment Act (Buy American Provision)

Bypass-Isolation Switch Options

14A1	Auxiliary contact to close in "Bypass to Normal" position.
14B1	Auxiliary contact to close in "Bypass to Emergency" position.
14T	Auxiliary contact to close when transfer switch is in "Automatic" position.
14U	Auxiliary contact to close when transfer switch is in "Isolate" position.
14V	Auxiliary contact to close when transfer switch is in "Test" position.
82E	LED Bypass status indicator, optional on G frame, 1600 to 4000 amps only. Standard for all other switches.

Meter and Communication Combinations

135L	ASCO Digital Power Meter monitors load source voltage, frequency, and current and calculating Power, Energy, and Power Factor.
150A	ASCO Digital Power Meter (Acc. 135L), Backup Power Source (Acc. 1PS1), Communications Module (Acc. 72EE2)
150B	5210 Power Meter with Moxa IO (Acc. 135SB), Backup Power Source (Acc. 1PS1), Comm. Module (Acc. 72EE2)

Heater

44A	120VAC, 208-240VAC and/or 440-480VAC Accessory 44 Strip heater designed to keep humidity and/or temperature inside ATS enclosure within acceptable levels. Includes mounting bracket with strip heater, thermostat, and terminal block.
------------	---

Withstand and Closing Ratings

Withstand and Closing Ratings for all 7000 SERIES Power Transfer Switches, including 0.5 second (30-cycle) designs.

Frame	Switch Rating (Amps)		Current Limiting Fuses				Specific Breaker			Time Based			Short Time Ratings ¹ (sec)													
	Transfer Switches	Bypass Switches	480V Max.	600V Max.	Max Size, A	Class	240V Max.	480V Max.	600V Max.	Time (sec)	240V Max.	480V Max.	600V Max.	480V Max.				600V Max.								
														0.13	0.2	0.3	0.5	0.1	0.13	0.3	0.5					
D	30	-	100kA	-	300	J	22kA	22kA	10kA	0.025	10kA	10kA	10kA	-	-	-	-	-	-	-	-	-	-	-	-	
D	70, 100	-	200kA	35kA	200	J	150kA	85kA	25kA	0.025	10kA	10kA	10kA	-	-	-	-	-	-	-	-	-	-	-	-	
D	150	-	35kA	35kA	200	RK1	150kA	85kA	25kA	0.025	10kA	10kA	10kA	-	-	-	-	-	-	-	-	-	-	-	-	
D	200	-	200kA	35kA	200	J	200kA	85kA	14kA	0.025	10kA	10kA	10kA	-	-	-	-	-	-	-	-	-	-	-	-	
D	230	-	35kA	35kA	200	RK1	200kA	85kA	14kA	0.025	10kA	10kA	10kA	-	-	-	-	-	-	-	-	-	-	-	-	
J	150, 200, 260	150, 200, 230, 260	200kA	200kA	600	J	200kA	200kA	42kA	0.05	65kA	42kA ²	35kA	7.5kA	-	-	-	-	-	-	-	-	-	-	-	-
J	400	400	200kA	200kA	800	J	65kA	50kA	42kA	0.05	65kA	42kA ²	35kA	7.5kA	-	-	-	-	-	-	-	-	-	-	-	-
J	600	600	200kA	200kA	800	L	65kA	85kA	42kA	0.05	65kA	42kA ²	35kA	7.5kA ³	-	-	-	-	-	-	-	-	-	-	-	-
H ⁴	600	600	200kA	200kA	1600	L	65kA	150kA	65kA	0.05	50kA	50kA	50kA	36kA	-	-	36kA	-	-	-	-	-	-	-	-	-
P ⁴	600	600	200kA	200kA	1600	L	65kA	150kA	65kA	0.05	50kA	50kA	50kA	36kA	30kA	36kA	-	-	-	-	-	-	-	-	-	-
P ⁴	800	800 - 1200	200kA	200kA	1600	L	65kA	150kA	65kA	0.05	50kA	50kA	50kA	36kA	30kA	36kA	-	-	-	-	-	-	-	-	-	-
H	800 - 1200	800 - 1200	200kA	200kA	1600 ⁵	L	65kA	150kA	65kA	0.05	50kA	50kA	50kA	36kA	-	-	36kA	-	-	-	-	-	-	-	-	-
Q ⁴	600-1600	600-1600	200kA	200kA	2000	L	65kA	65kA	65kA	0.05	65kA	65kA	65kA	50kA	-	-	50kA	-	-	-	-	-	-	-	-	-
S ⁴	800 - 1200	800 - 1200	200kA	200kA	2500	L	100kA	100kA	65kA	0.05	100kA	100kA	65kA	65kA	-	-	65kA	-	-	-	-	-	-	-	-	-
G ⁴	1000 - 1200	1000 - 1200	200kA	200kA	2000	L	85kA	85kA	85kA	0.05	85kA	85kA	85kA	-	-	-	-	-	-	-	-	-	-	-	-	-
G	1600 - 2000 (Front Connected TS Only)	1600 - 2000	200kA	200kA	2500	L	85kA	85kA	85kA	0.05	85kA	85kA	85kA	42kA	36kA	-	-	-	-	-	-	-	-	-	-	-
G ⁴	1600 - 2000	1600 - 2000	200kA	200kA	3000	L	200kA	200kA	100kA	0.05	100kA	100kA	100kA	42kA	36kA	42kA	42kA	-	-	-	-	-	-	-	-	-
S ⁴	1600 - 2000	1600 - 2000	200kA	200kA	2500	L	100kA	100kA	85kA	0.05	100kA	100kA	85kA	85kA	65kA	85kA	65kA	85kA	65kA	-	-	-	-	-	-	-
G	2600 - 3000	2600 - 3000	200kA	200kA	4000	L	125kA ⁶	125kA ⁶	100kA	0.05	100kA	100kA	100kA	42kA	36kA	42kA	42kA	-	-	-	-	-	-	-	-	-
G ⁴	3200	-	200kA	-	4000	L	100kA	100kA	-	0.05	100kA	100kA	-	-	-	-	-	-	-	-	-	-	-	-	-	
G	4000	4000	200kA	200kA	5000	L	100kA	100kA	100kA	0.05	100kA	100kA	100kA	85kA	65kA	-	65kA	-	-	-	-	-	-	-	-	-
U ⁴	2600 - 4000	2600 - 4000	200kA	200kA	5000	L	125kA	125kA	125kA	0.05	125kA	125kA	125kA	100kA	-	-	100kA	-	-	-	-	-	-	-	-	-

Notes:

- Short Time Ratings are provided for selective coordination of overcurrent protection devices.
- Switches utilizing overlapping neutral (code C) have 35kA, 0.05-second, time-based rating at 480V max.
- Short Time Rating applies to 600A bypass switch only. The 600A transfer switch does not have a Short Time Rating.
- These frames are only available in the 7000 SERIES product line.
- Max. fuse rating is 1200A on front-connected H-frame switches.
- Rating shown is for bypass switches only. Transfer switch rating is 100kA.

All units are RMS Symmetrical Amperes.

All Withstand and Closing Rating (WCR) values are established by testing in accordance with UL 1008. For the latest ratings, including transfer switch ratings when used with specific circuit breakers, see **ASCO Publication 1128** for more WCR information.

Application characteristics may permit higher WCRs for certain switch sizes. Contact ASCO Power Technologies for more information.

Contact ASCO for Service Entrance Switch ratings.

Power Knowledge

[UL 1008 Transfer Switch Withstand and Closing Ratings](#)

[Performance Testing for Transfer Switches](#)

Additional 7000 SERIES Transfer Switch Information

Transfer Switches	Controls	Technical Information	
Bypass-Isolation	Group 5 Controller & Power Control Center	Drawings	Withstand and Closing Ratings
Service Entrance		Wiring Diagrams	Weights, Dimensions & Ordering Info

Life Is On



ASCO Power Technologies - Global Headquarters
160 Park Avenue
Florham Park, NJ 07932
Tel: 800 800 ASCO

www.ascopower.com
customercare@ascopower.com