

OLYMPIAN™

G35LG2 35 kW

G35LG2

Industrial Spark-Ignited Generator Set

EPA Certified Stationary Emergency

5.4L

Standby Power Rating
35 kW 44 kVA 60 Hz

Prime Power Rating*
32 kW 39 kVA 60 Hz

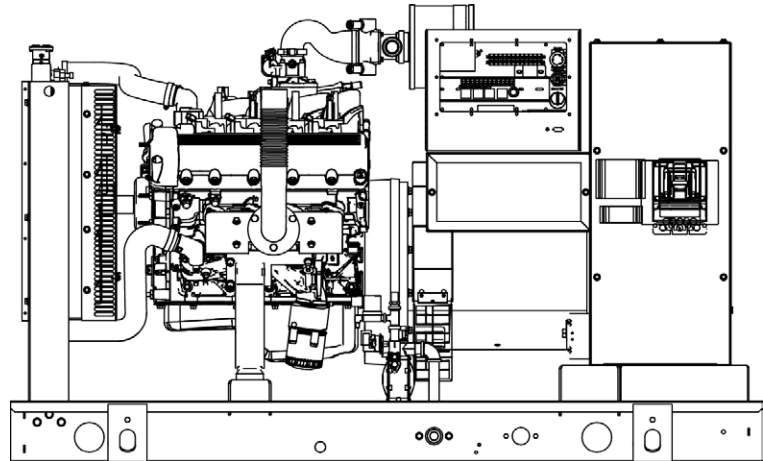

*EPA Certified Prime ratings are not available in the U.S. or its Territories

Image used for illustration purposes only

Codes and Standards

Olympian products are designed to the following standards:



UL2200, UL508, UL142, UL498



NFPA70, 99, 110, 37



NEC700, 701, 702, 708



ISO9001, 8528, 3046, 7637, Pluses #2b, 4



NEMA ICS10, MG1, 250, ICS6, AB1



ANSI C62.41

American National Standards Institute



IBC 2009, CBC 2010, IBC 2012, ASCE 7-05,
ASCE 7-10, ICC-ES AC-156 (2012)

Prime power or standby service, Olympian Natural gas or Propane fuel generator sets deliver dependable, clean, economical power – even in the most demanding conditions – and Olympian gensets are available in a wide range of configurations with optional equipment.

Olympian generator sets are designed, engineered and manufactured for optimal performance. All major components are tested individually; once assembled, the entire unit is tested at and above 100% of rated load for safety and operation.

These complete, ready-to-run packages have another distinct advantage. They all come with the comprehensive service and support of Cat® dealers – beginning with prompt delivery and ongoing support throughout the life of the generator set.

OLYMPIAN™

LG Series

Standard Features

ENGINE SYSTEM

General

- Oil Drain Extension
- Air Cleaner
- Fan Guard
- Stainless Steel flexible exhaust connection
- Critical Exhaust Silencer (enclosed only)
- Factory Filled Oil
- Radiator duct adapter (open set only)

Fuel System

- Primary and Secondary Fuel Shutoff
- Flexible Fuel Line - NPT Connection

Cooling System

- Closed Coolant Recovery System
- UV/Ozone resistant hoses
- Factory-installed Radiator
- Radiator drain extension
- 50/50 Ethylene glycol antifreeze

Engine Electrical System

- Battery charging alternator
- Battery Cables
- Battery Tray
- Solenoid activated starter motor
- Rubber-booted engine electrical connections

ALTERNATOR SYSTEM

- Class H insulation material
- 2/3 Pitch
- Skewed Stator
- Brushless Excitation
- Sealed Bearings
- Amortisseur winding
- Full load capacity alternator

GENERATOR SET

- Internal Genset Vibration Isolation
- Separation of circuits - high/low voltage
- Separation of circuits - multiple breakers
- Wrapped Exhaust Piping
- Standard Factory Testing
- 2 Year Limited Warranty (Standby rated Units)
- 1 Year Warranty (Prime rated units)
- Silencer mounted in the discharge hood (enclosed only)

ENCLOSURE (if selected)

- Rust-proof fasteners with nylon washers to protect finish
- High performance sound-absorbing material
- Gasketed doors
- Stamped air-intake louvers
- Air discharge hoods for radiator-upward pointing
- Stainless steel lift off door hinges
- Stainless steel lockable handles

CONTROL SYSTEM



Control Panel

- Digital H Control Panel - Dual 4x20 Display
- Programmable Crank Limiter
- 7-Day Programmable Exerciser
- Special Applications Programmable PLC
- RS-232/485
- All-Phase Sensing DVR
- Full System Status
- Utility Monitoring
- Low Fuel Pressure Indication
- 2-Wire Start Compatible
- Power Output (kW)
- Power Factor
- kW Hours, Total & Last Run

- Real/Reactive/Apparent Power
- All Phase AC Voltage
- All Phase Currents
- Oil Pressure
- Coolant Temperature
- Coolant Level
- Engine Speed
- Battery Voltage
- Frequency
- Date/Time Fault History (Event Log)
- Isochronous Governor Control
- Waterproof/sealed Connectors
- Audible Alarms and Shutdowns
- Not in Auto (Flashing Light)
- Auto/Off/Manual Switch
- E-Stop (Red Mushroom-Type)
- NFPA110 Level I and II (Programmable)
- Customizable Alarms, Warnings, and Events
- Modbus protocol
- Predictive Maintenance algorithm
- Sealed Boards
- Password parameter adjustment protection

- Single point ground
- 15 channel data logging
- 0.2 msec high speed data logging
- Alarm information automatically comes up on the display

Alarms

- Oil Pressure (Pre-programmable Low Pressure Shutdown)
- Coolant Temperature (Pre-programmed High Temp Shutdown)
- Coolant Level (Pre-programmed Low Level Shutdown)
- Low Fuel Pressure Alarm
- Engine Speed (Pre-programmed Over speed Shutdown)
- Battery Voltage Warning
- Alarms & warnings time and date stamped
- Alarms & warnings for transient and steady state conditions
- Snap shots of key operation parameters during alarms & warnings
- Alarms and warnings spelled out (no alarm codes)

LG Series

Configurable Options

ENGINE SYSTEM

- General
- Engine Block Heater
 - Oil Heater
 - Air Filter Restriction Indicator
 - Stone Guard (Open Set Only)
 - Critical Exhaust Silencer (Open Set Only / Standard on Ultra Low Emissions Option)

Engine Electrical System

- 10A UL battery charger
- 2.5A UL battery charger
- Battery Warmer

ALTERNATOR SYSTEM

- Alternator Upsizing
- Anti-Condensation Heater
- Tropical coating
- Permanent Magnet Excitation

GENERATOR SET

- Extended Factory Testing (3 Phase Only)
- IBC Seismic Certification
- 8 Position Load Center
- 2 Year Extended Warranty
- 5 Year Warranty
- 5 Year Extended Warranty

CIRCUIT BREAKER OPTIONS

- Main Line Circuit Breaker
- 2nd Main Line Circuit Breaker
- Shunt Trip and Auxiliary Contact
- Electronic Trip Breakers

ENCLOSURE

- Standard Enclosure
- Level 1 Sound Attenuation
- Level 2 Sound Attenuation
- Steel Enclosure
- Aluminum Enclosure
- 150 MPH Wind Kit
- 12 VDC Enclosure Lighting Kit
- 120 VAC Enclosure Lighting Kit
- AC/DC Enclosure Lighting Kit
- Door Alarm Switch

CONTROL SYSTEM

- | | | |
|--|--|--|
| <ul style="list-style-type: none"> <input type="checkbox"/> 21-Light Remote Annunciator <input type="checkbox"/> Remote Relay Panel (8 or 16) <input type="checkbox"/> Oil Temperature Sender with Indication Alarm | <ul style="list-style-type: none"> <input type="checkbox"/> Remote E-Stop (Break Glass-Type, Surface Mount) <input type="checkbox"/> Remote E-Stop (Red Mushroom-Type, Surface Mount) <input type="checkbox"/> Remote E-Stop (Red Mushroom-Type, Flush Mount) | <ul style="list-style-type: none"> <input type="checkbox"/> Remote Communication - Modem <input type="checkbox"/> Remote Communication - Ethernet <input type="checkbox"/> 10A Run Relay <input type="checkbox"/> Ground fault indication and protection functions |
|--|--|--|

Engineered Options

ENGINE SYSTEM

- Coolant heater ball valves
- Fluid containment pans

GENERATOR SET

- Special Testing
- Battery Box

CONTROL SYSTEM

- Spare inputs (x4) / outputs (x4) - H Panel Only
- Battery Disconnect Switch

ALTERNATOR SYSTEM

- 3rd Breaker Systems

ENCLOSURE

- Motorized Dampers
- Enclosure Ambient Heaters

Rating Definitions

Standby – Applicable for a varying emergency load for the duration of a utility power outage with no overload capability.

Prime – Applicable for supplying power to a varying load in lieu of utility for an unlimited amount of running time. A 10% overload capacity is available for 1 out of every 12 hours. The Prime Power option is only available on International applications.

Power ratings in accordance with ISO 8528-1, Second Edition dated 2005-06-01, definitions for Prime Power (PRP) and Emergency Standby Power (ESP).

ENGINE SPECIFICATIONS**General**

Cylinder #	8
Type	V
Displacement - L (Cu In)	5.4 (329.53)
Bore - mm (in)	90.17 (3.55)
Stroke - mm (in)	105.92 (4.17)
Compression Ratio	9:1
Intake Air Method	Naturally Aspirated
Number of Main Bearings	4
Connecting Rods	Forged
Cylinder Head	Aluminum
Cylinder Liners	No
Ignition	Single Fire
Pistons	Aluminum Alloy
Crankshaft	Nodular Iron
Lifter Type	Hydraulic
Intake Valve Material	Steel Alloy
Exhaust Valve Material	Hardened Steel
Hardened Valve Seats	Yes

Engine Governing

Governor	Electronic
Frequency Regulation (Steady State)	+/- 0.25%

Lubrication System

Oil Pump Type	Gear
Oil Filter Type	Full-flow spin-on cartridge
Crankcase Capacity - L (qts)	5.7 (6)

Cooling System

Cooling System Type	Pressurized Closed Recovery
Water Pump Flow - gpm (lpm)	38 (144)
Fan Type	Pusher
Fan Speed (rpm)	2143
Fan Diameter mm (in)	508 (20)
Coolant Heater Wattage	1500
Coolant Heater Standard Voltage	120 V

Fuel System

Fuel Type	Natural Gas, Propane Vapor
Carburetor	Down Draft
Secondary Fuel Regulator	Standard
Fuel Shut Off Solenoid	Standard
Operating Fuel Pressure	7" - 11" H ₂ O

Engine Electrical System

System Voltage	12 VDC
Battery Charging Alternator	Standard
Battery Size	See Battery Index 0161970SBY
Battery Voltage	12 VDC
Ground Polarity	Negative

ALTERNATOR SPECIFICATIONS

Standard Model	390
Poles	4
Field Type	Revolving
Insulation Class - Rotor	H
Insulation Class - Stator	H
Total Harmonic Distortion	<5%
Telephone Interference Factor (TIF)	<50
Standard Excitation	Brushless
Bearings	Sealed Ball
Coupling	Flexible Disc
Prototype Short Circuit Test	Yes

Voltage Regulator Type	Full Digital
Number of Sensed Phases	All
Regulation Accuracy (Steady State)	+/- 0.25%

LG Series

operating data

POWER RATINGS

	Natural Gas		Propane Vapor	
	kW	Amps	kW	Amps
Single-Phase 120/240 VAC @1.0pf	35 kW	146	35 kW	146
Three-Phase 120/208 VAC @0.8pf	35 kW	121	35 kW	121
Three-Phase 120/240 VAC @0.8pf	35 kW	105	35 kW	105
Three-Phase 277/480 VAC @0.8pf	35 kW	53	35 kW	53
Three-Phase 346/600 VAC @0.8pf	35 kW	42	35 kW	42

STARTING CAPABILITIES (sKVA)

		sKVA vs. Voltage Dip											
		480 VAC						208/240 VAC					
Alternator	kW	10%	15%	20%	25%	30%	35%	10%	15%	20%	25%	30%	35%
Standard	35	24	36	48	60	72	84	18	27	36	45	54	63
Upsize 1	40	27	41	54	68	81	95	20	31	41	51	61	71
Upsize 2	50	34	52	69	86	103	120	26	39	52	65	77	90
Upsize 3	60	42	63	83	104	125	146	32	47	62	78	94	110

FUEL CONSUMPTION RATES*

Natural Gas – ft ³ /hr (m ³ /hr)		Propane Vapor – ft ³ /hr (m ³ /hr)	
Percent Load	Standby	Percent Load	Standby
25%	239 (6.8)	25%	69.8 (2.0)
50%	409 (11.6)	50%	119.7 (3.4)
75%	553 (15.7)	75%	161.6 (4.6)
100%	682 (19.3)	100%	219.8 (6.2)

*Fuel supply installation must accommodate fuel consumption rates at 100% load.

COOLING

		Standby
Air Flow (inlet air combustion and radiator)	ft ³ /min (m ³ /min)	2460 (69.7)
Coolant Flow per Minute	gpm (lpm)	38 (144)
Coolant System Capacity	gal (L)	3 (11.36)
Heat Rejection to Coolant	BTU/hr	144,000
Max. Operating Air Temp on Radiator	°F (°C)	122 (50)
Max. Operating Ambient Temperature (before derate)	°F (°C)	110 (43.3)
Maximum Radiator Backpressure	in H ₂ O	0.5

COMBUSTION AIR REQUIREMENTS

	Standby
Flow at Rated Power cfm (m ³ /min)	87 (2.5)

ENGINE

		Standby
Rated Engine Speed	rpm	1800
Horsepower at Rated kW**	hp	54
Piston Speed	ft/min (m/min)	1251 (381)
BMEP	psi	72

** Refer to "Emissions Data Sheet" for maximum bHP for EPA and SCAQMD permitting purposes.

EXHAUST

		Standby
Exhaust Flow (Rated Output)	cfm (m ³ /min)	260 (7.4)
Maximum Recommended Back Pressure	inHg	1.5
Exhaust Temp (Rated Output)	°F (°C)	900 (482)
Exhaust Outlet Size (Open Set)	in	2.5" I.D. Flex (No muffler)

Deration – Operational characteristics consider maximum ambient conditions. Derate factors may apply under atypical site conditions. Please consult a CAT® Dealer for additional details. All performance ratings in accordance with ISO3046, BS5514, ISO8528 and DIN6271 standards.

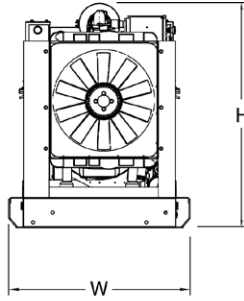
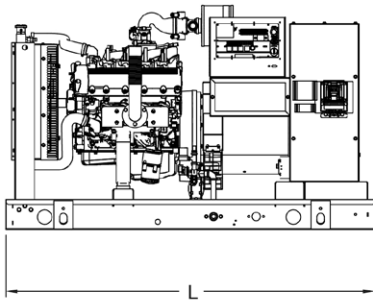

OPEN SET (Includes Exhaust Flex)

L x W x H in (mm)	76 (1930) x 37.4 (949.9) x 47 (1193.8)
Weight lbs (kg)	1575 (714)

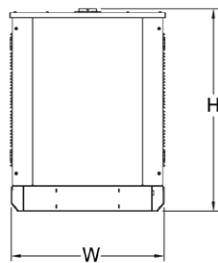
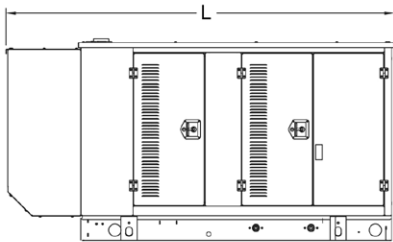

STANDARD ENCLOSURE

L x W x H in (mm)	94.8 (2408.9) x 38 (965.1) x 49.5 (1258.1)
Weight lbs (kg)	Steel: 2100 (952) Aluminum: 1754 (795)

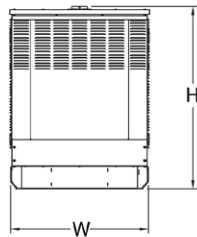
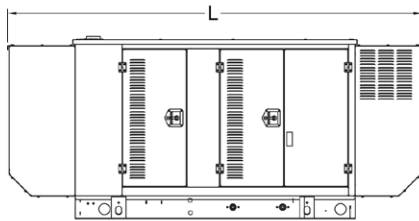

LEVEL 1 ACOUSTIC ENCLOSURE

L x W x H in (mm)	112.5 (2857.1) x 38 (965.1) x 49.5 (1258.1)
Weight lbs (kg)	Steel: 2140 (970) Aluminum: 1767 (801)

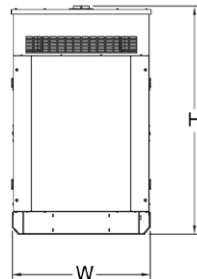
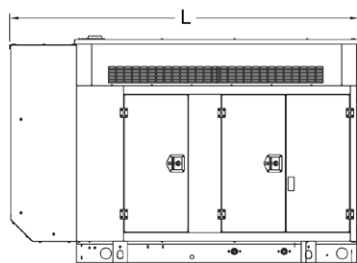

LEVEL 2 ACOUSTIC ENCLOSURE

L x W x H in (mm)	94.8 (2407) x 38 (965.1) x 62 (1573.9)
Weight lbs (kg)	Steel: 2328 (1056) Aluminum: 1831 (830)